

Hitachi Electric Motors For Industrial application

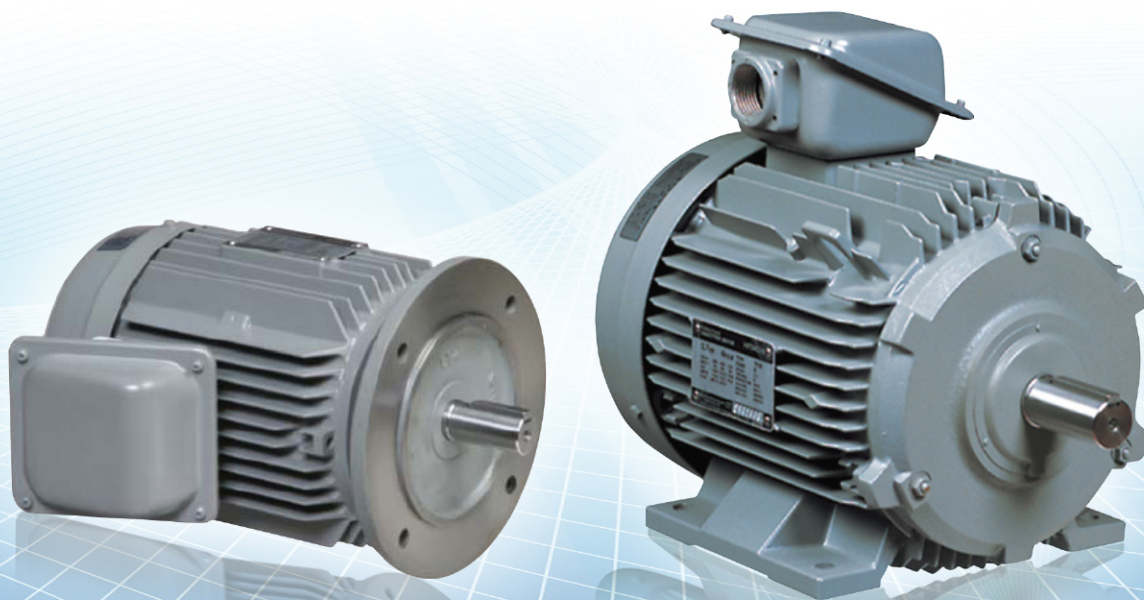

Three-Phase Motors



IP44 Series

Foot / Flange Mount
1/7~175HP (0.1~132kW)
2 / 4 / 6 / 8 pole

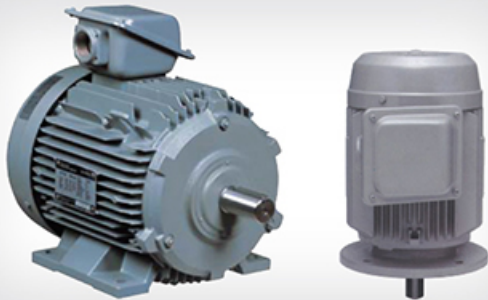

IP55 Series

Foot / Flange Mount
1/2~175HP (0.4~132kW)
2 / 4 / 6 / 8 pole

Single-Phase Motors



Split-Phase Start

1/8~1/2HP (0.09~0.75kW)
4 pole



Capacitor Start

1/8~1HP (0.09~0.75kW)
4 pole



Capacitor Start Capacitor Run

1.5~10HP (1.1~7.5kW)
4 pole

Historical transition of Hitachi Motor Development.

Motor Size: 5HP (3.7kW 4P)



Ratio of Weight

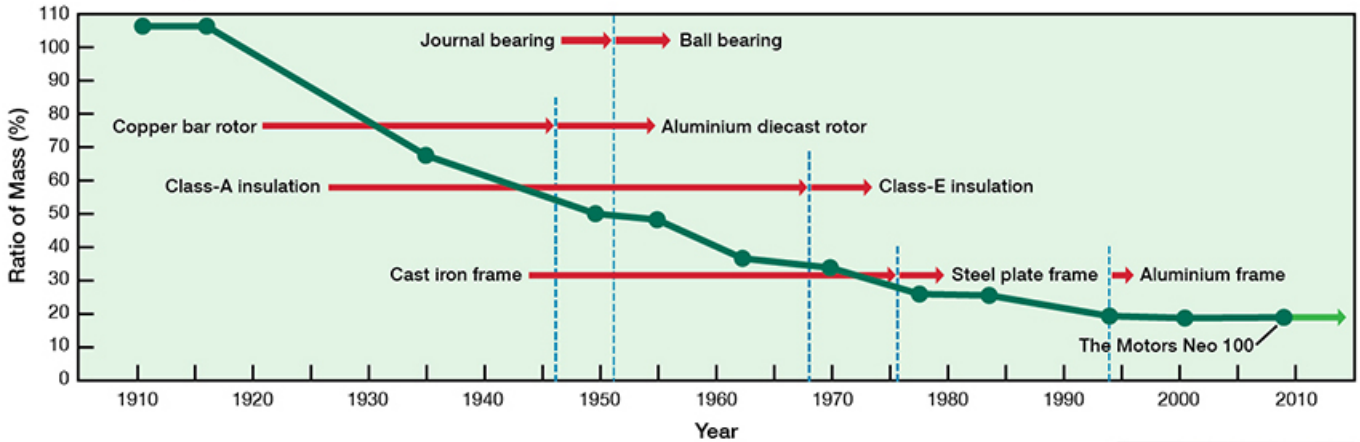

Facilities of Production and Development.



Hitachi Narashino Plant in Japan



Central Research Laboratory



Administrative Division

Production Plant in Thailand.



High performance with latest technologies.

2. The insulated lead-wire has high performance and efficiency.

In our high technology, we developed high quality insulated wire and varnish that can support various hostile environments, even under high temperature.

1. Aluminum-alloy frame is beneficial for light weight.

Aluminum-alloy is used as raw material of motor housing (Used in parts for airplane, shinkansen, etc), which makes the motor to effectively ventilate heat and provides light weight

4. Using high quality bearings also adopted high graded grease.

On of major importance for motor is quality of bearings. The Hitachi motors are used the high quality one with high graded grease.

5. Liquid gasket seal (For IP55 construction)

Using high quality liquid seal for IP55 series in order to establish durability and long life for the motors.

6. End brackets (Front and back) that have a robust construction for strength.

The end brackets are made by cast iron in order to establish robustness for motor construction.

7. Special slot and compact coil effect to lower sound and high performance.

From a start for running, the motor can smoothly start with high torque and reduces a damage for machine because of low vibration. The motor does not harm construction in the motor and the machine.

3. Silent and highest cooling efficiency.

The ventilation process is developed from CAE (Computer Aided Engineering) and has high efficiency fan with quietness. This high quality motor is accomplished through the effective use aluminum alloy.

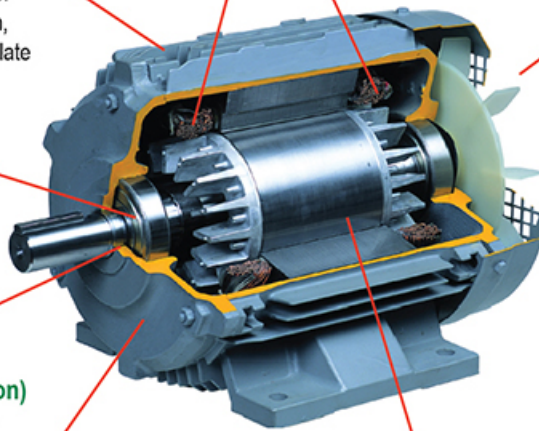

Easy handing on site because of light weight.

Aluminum alloy housing realize light weight.

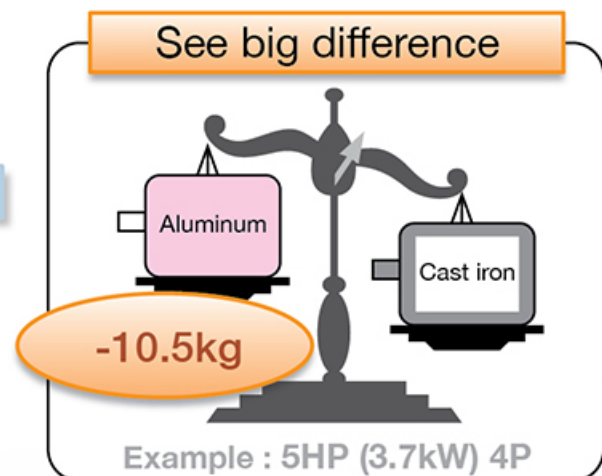
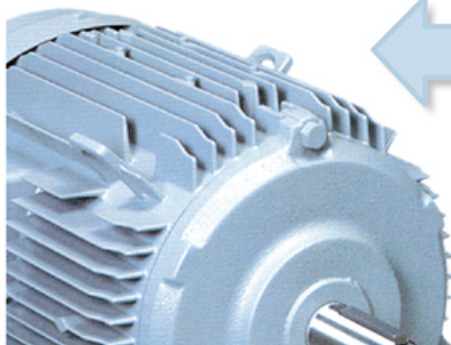

The average weight decreased by 30%

Furthermore technologies on motor design & development.

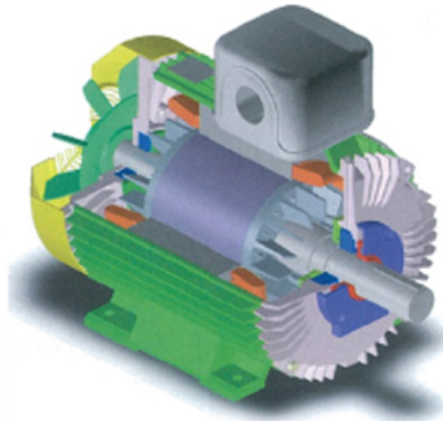
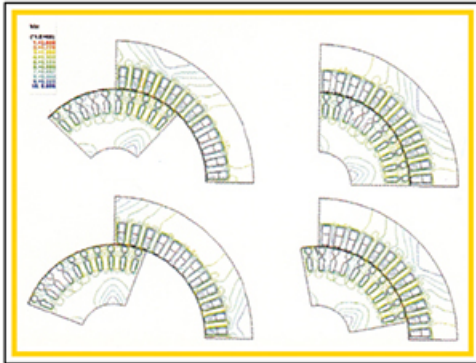

Secret formula of silence is energy

We have researched and found the right vibrational level and calculated the durability of motor structure by computer systems. You can rely upon our high-quality motors. We have also discovered and designed the methods that could reduce high frequency while machines are running in addition, we have planned to utilize brand-new materials with high-precision machines, which pertain technology that could control silence and low vibration. We are proud to present our new technology and have strived to produce products that have the best quality.

Usage life of lead wires in a heat situation

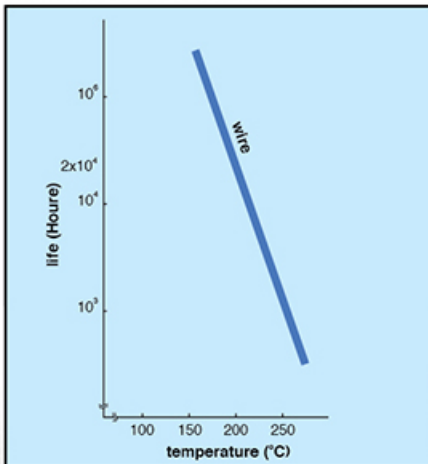

Reliability of high-power torque energy

Hitachi motors have been designed from slot in rotor for aluminum injection, which is a specific technique that provides high-power torque for better start. You can notice from the start to a running period. You would find that Hitachi motor have a very smooth start with an increase in usage capacity.

Energy source Compact-Coil structure

One of our new technologies is Compact Coil. When the Coil is small, It can control all system errors with high capacity. Insulate has a round shape placed parallel to each other in which it to create high conserved energy. As a result, internal structure has an increase in space, which provides a better ventilating system for cooling efficiency.



Hitachi **WR Grease** has capability of tolerating heat four times more than ordinary lithium. The grease can also be operated or tolerated from the highest temperature to the lowest temperature with excellent performance. On the other hand, it can extend the usage life of motors because of shield Bearing technology.

The test result of grease in high temperature

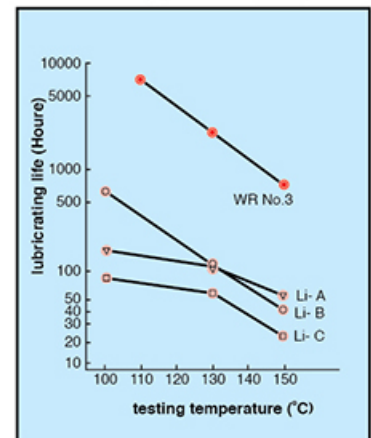

Main Feature for Single-phase motors.

More reliable in various fields.

Economical and High Efficiency

Following IEC standard, insulation class E comes with low vibration level and low noise, which is the advantage of 3-phase motor developed from 1-phase motor of Hitachi. Your satisfaction is guaranteed because it can be used in a variety of industries with high engine performance. We believe in high quality products in which we strictly control our manufacturing process for high quality and performance. Therefore, high engine performance with low vibration level makes our Hitachi motor one of the best and highly satisfies our customers worldwide.

Compact size

Hitachi Motor uses housing-steel iron (state of the art technology used widely), aluminum alloy cover for impact protection, and the modern shape.

Switch works constantly

The centrifugal switch was developed that install to the rotor. It can be guaranteed that the switch will work constantly.

Efficient Ventilation System

We use a high-performance ventilation system that effectively exchanges air from inside to outside environment with dust protection into the centrifugal switch. All of these features contribute to a high performance machine.

High temperature resistance plastic insulator



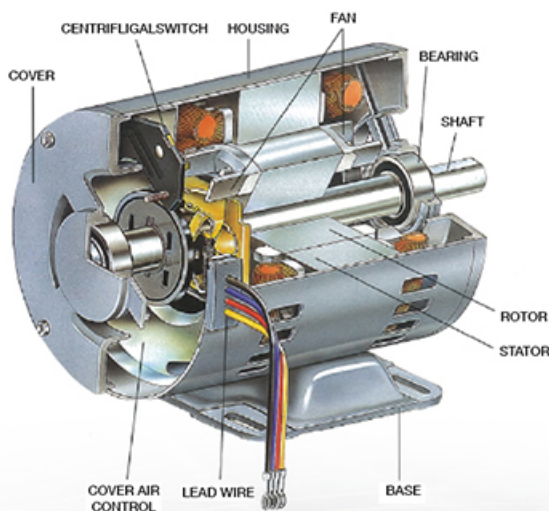
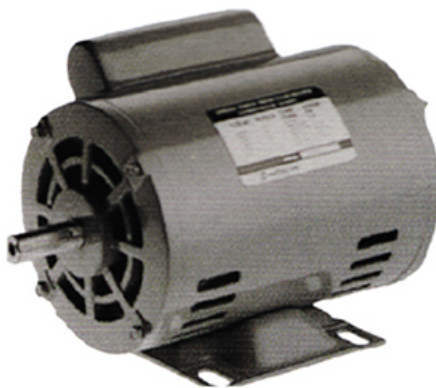

We carefully choose to use plastic insulation that can support high heat, which is one of the components that makes Hitachi Motor one of the safest motor used in industries.



SPECIFICATIONS

ITEM		SPECIFICATION		
STANDARD		JIS C4203, 4034		
RATING		CONTINUOUS [S1]		
INSULATION CLASS		E TYPE		
ENCLOSURES TYPE PROTECTION		ENCLOSURES		PROTECTION
		OPEN TYPE	DRIP PROOF	EFOU-KT, KA, KQ EFOUP-KT, KA, KQ
VOLTAGE FREQUENCY		220V 50Hz		
TYPE OF CABLE		Made from high temperature resistance plastic (end of pole conduct electric current)		
NUMBER OF CABLE		4 WIRES (1/4-1/3 HP-KT-KR 2-10 HP-KQ) 3 WIRES (1/2-1.5 HP-KR-KQ)		
COLOUR		Regal gray (MUNSELL 8.9Y5.1/0.3)		
TRANSMISSION		DIRECT COUPLING OR BELT DRIVE		
RATATION		CW (VIEW FROM MOTOR DRIVE END)		
ENVIRON- MENT	TEMPERATURE	-20 °C - 40 °C		
	HUMIDITY	MaX 90%RH		
	ALTITUDE	MaX 1,000 m		
	ESTABLISHMENT	IN DOOR		
ATMOSPHERE		NO CORROSIVE GAS, NO EXPLOSIVE GAS, NO STEAM, NO DEW, LITTLE DUST		

Variety of motor

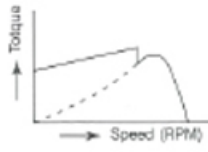
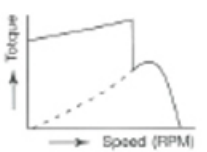
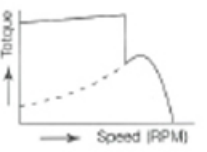
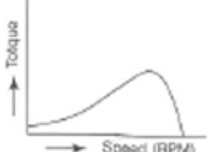
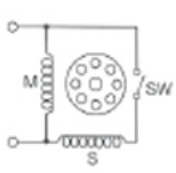
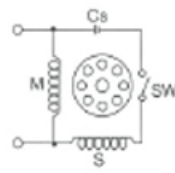
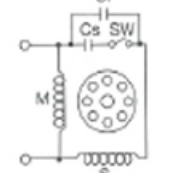
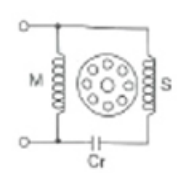
TYPE	SPLIT-PHASE START	CAPACITOR START	CAPACITOR START CAPACITOR RUN	CAPACITOR RUN
MODEL	KT	KR	KQ	KP
APPEARANCE				
CHARACTERISTIC -CURVE				
CONNECTION				
	M : Main Coil Gs : Starting Capacitor Cr : Running Capacitor S : Starting coil SW : Centrifugal Switch			
FEATURES	Simple Structure	High Starting Torque	High Starting Torque Lower Running Current	Low Starting Torque Lower Running Current
APPLICATION	Drilling Machine Blower	Conveyer Pump	Compressor	Fan

The Wiring Connection and Propelling Direction

1/4HP, 1-3HP-KT

4 LEAD WIRE

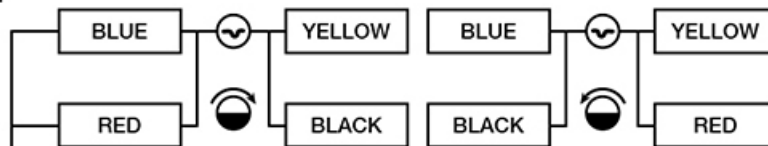

1/2HP-KT - 10HP-KQ

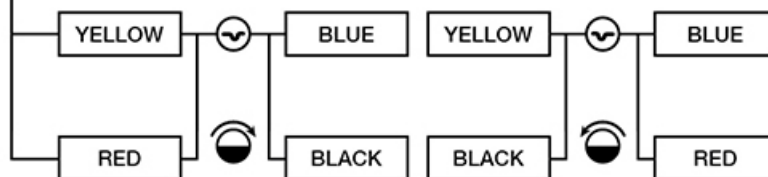

3 LEAD WIRE





Three-phase Motors

Basic Specifications

Item	Specifications			
Standard	JEC-2137-2000, JIS C 4210, 4034, ect.			
Rating	Continuous [S1]			
Insulation Class	2, 4, 6 Pole (8 Pole for same range)			
	B Type		~180 M	
	F Type		180 L~	
Enclosures Type	Enclosures		Type	Protection
	Indoor	Fan cooled type Vertical Fan cooled type	TFO-K, KK VTFO-K, KK	IP44
Protection	Outdoor	Fan cooled type Vertical Fan cooled type	TFO-K, KK VTFO-K, KK	IP55
Voltage, Frequency	1/2 ~ 5 HP : 220/380V 50Hz 7.5HP ~ : 380/415V 50 Hz			
Number of Cable	~ 5 HP 6 Wires (Direct starting 220V or 380V)			
	7.5 HP ~ 6 Wires (Star λ - Δ Delta starting)			
	2 pole 30 HP ~ 4 pole 40 HP ~ 6 pole 50 HP ~		12 Wires (Star λ - Δ Delta starting)	
Color	Alcron gray			
Transmission	2 pole 15 HP ~ Direct coupling 2 pole ~ 10 HP and 4 pole ~ Direct coupling or Belt drive			
Rotation	CCW (View from motor drive end)			
Environment	Temperature	-30 ~ 40°C		
	Humidity	Enclosed type Max 95% RH		
	Altitude	Max 1,000 m		
	Establishment	[IP44] Indoor type, [IP44 Special, IP55] Outdoor type		
Atmosphere	No corrosive gas, No explosive gas No Steam, No dew, little dust			

Nameplate on motors

Model : CE Version

THREE PHASE INDUCTION MOTOR		HITACHI	
MODEL : TFO-K (TFOD-112M)-4P		RATING	S1
5 HP	4 POLE	TH. CLASS	F
VOLTS 220 380 HERTZ 50 50 AMP'S 13.8 8.0 RPM 1410 1410 STANDARD EN 60034-1		AMB. TEMP.	40 °C
		PROTECTION	IP55
 		COOLING	IC411
		BRG. D. S.	6306ZZ
		BRG. O. S.	6306ZZ
		WEIGHT	28 kg.
Hitachi Industrial Technology (Thailand), Ltd.		MFG. No.	205830

The Wiring Connection and Propelling Direction

Circuit Diagram for the use of motor wiring connection

6-wire 220/380V

Connect to power source to start-up

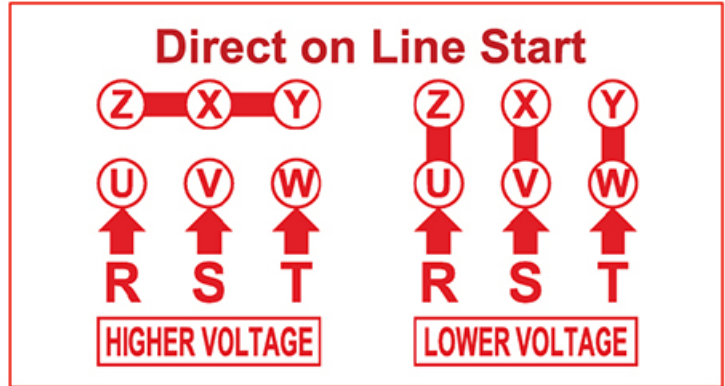
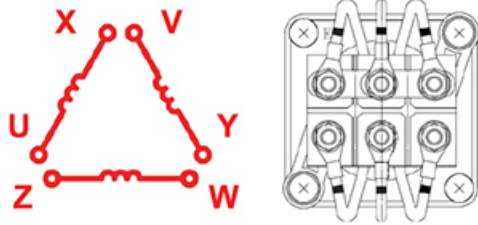

6-wire 380/415V

Connect to power source to start-up or start

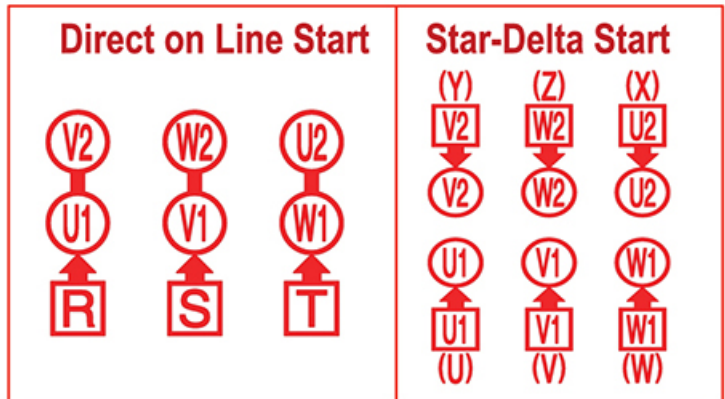
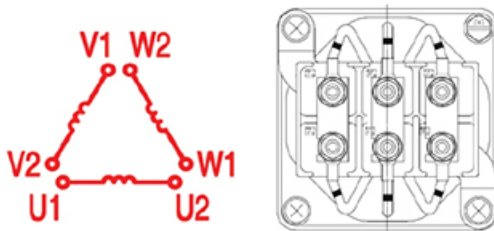

12-wire 200/380/400V

Connect to power source to start-up or start

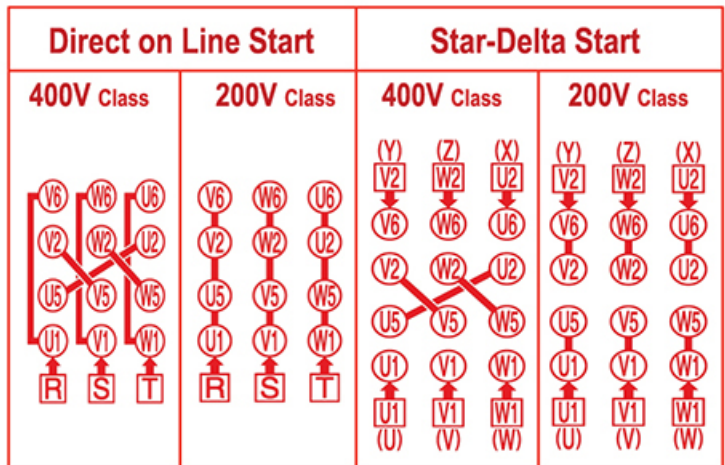
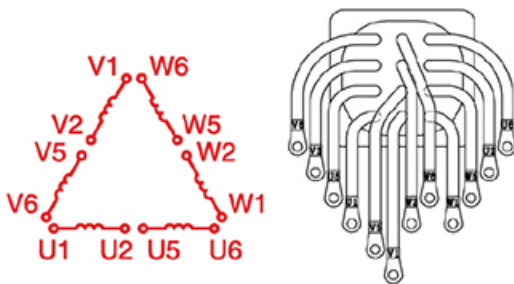

Rotation

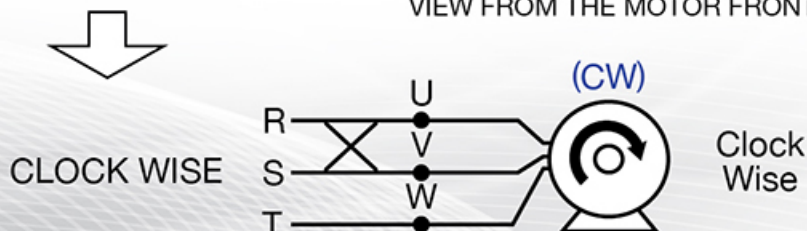
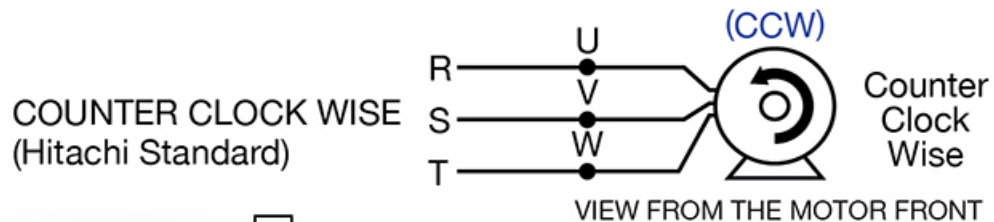

Three-Phase Induction Motors

Totally Enclosed Fan-Cooled Type (TEFC)
 IP44 Series / Foot Mount Type [TFO-K(KK)]
 1/7~175HP (0.1~132kW)

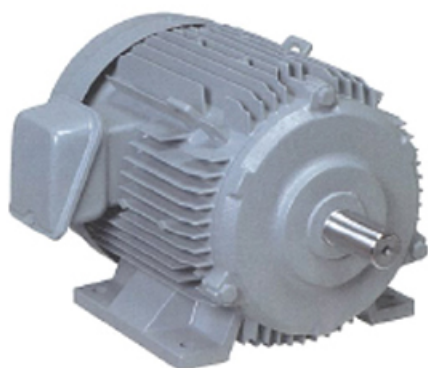

Model:

xxHP or kW TFO-K(KK) xP IP44

Output

No of pole

Item	Specifications	
Motor Output	1/4~175HP (0.2~132kW)	
Rating	Continuous [S1]	
Number of pole	2, 4, 6 pole [8 Pole : only some range]	
Insulation Class	B type	~180 M
	F type	180 L~
Enclosure	IP44 (Outdoor type is also available)	
Voltage, Frequency	Consult to nearest representative	
Number of Cable	~5 HP 6 Wires (Direct starting 220V or 380V)	
	7.5 HP ~ 6 Wires (Star Δ-Δ Delta Starting)	
	2 pole 30 HP ~	12 Wires (Star Δ-Δ Delta Starting)
	4 pole 40 HP ~	
6 pole 50 HP ~		
Color	Alcron gray	
Rotation	CCW (View from motor drive end)	
Environment	Temperature Humidity Altitude	-30 ~ 40 °C Enclosed type Max 95% RH Max 1,000 m

Type From	Frame size	Out Put(HP)			Insulation	Flg. No	Dimension in mm														
		2pole	4pole	6pole			L	R	A	B	D	KL	K	KD	J	H	C	F	E	N	M
TO-K	63M	-	1/7	-	B	1	186	103	80	-	116	-	-	-	-	121	63 ^{0.05}	40	50	100	130
		-	1/4	-	B	1	186	103	90	-	116	-	-	-	-	121	63 ^{0.05}	40	50	100	130
TFO-K	71M	1/2	1/2	-	B	2	236	120	116	87	145	129	25	22	30	146.5	71 ^{0.05}	45	56	115	140
	80M	1	1	1/2	B	2	268.5	140	128.5	97	163	135	25	22	35	161.5	80 ^{0.05}	50	62.5	125	160
	90L	2/3	2	1	B	3	315	168.5	146.5	116	180	145	49	22	35.5	180	90 ^{0.05}	62.5	70	155	170
	100L	-	3	2	B	3	356	193	163	130.5	199	153	51.5	28	45	199.5	100 ^{0.05}	70	80	175	195
	112M	5	5	3	B	3	372	200	172	137.5	223	166.5	51.5	28	45	223.5	112 ^{0.05}	70	95	175	224
TFO-KK	132S	7.5/10	7.5	5	B	4	427.5	239	188.5	153	250	197	56	36	50	257	132 ^{0.05}	70	108	175	250
	132M	-	10	7.5	B	4	465.5	258	207.5	172	250	197	56	36	50	257	132 ^{0.05}	89	108	212	250
	160M	15/20	15	10	B	4	595	323	272	198	292	256	107	52	60	303.5	160 ^{0.05}	105	127	300	300
	160L	25	20	15	B	4	595	345	250	220	292	256	107	52	60	303.5	160 ^{0.05}	127	127	300	300
	180M	30	25/30	20	B	4	643	351.5	291.5	226.5	340	279	75	52	90	350	180 ^{0.05}	120.5	139.5	300	350
TFO-KK	180L	40	40	25/30	F	5	716	370.5	345.5	245.5	340	-	75	52	90	494	180 ^{0.05}	139.5	139.5	335	350
	(200LB) 200L	50 60	50 60	40 50	F	(6) 5	(790) 820	(395.5) 425.5	394.5	(276.5) 270.5	391	-	85	78	110	541.5	200 ^{0.05}	152.5	159	365	400
	(225SB) 225S	75	75	60	F	(6) 5	(826.5) 856.5	(402) 432	424.5	(283) 270.5	391	-	85	78	110	566.5	225 ^{0.05}	143	178	350	450
	(250SD) 250M	100	100	75	F	7	(909) 939	(433.5) 463.5	475.5	(313.5) 312.5	490	-	-	78	100	735	250 ^{0.05}	155.5	203	428	500
	(250MD) 250M	120	120	100	F	7	(909) 939	(452.5) 482.5	456.5	(332.5) 331.5	490	-	-	78	100	735	250 ^{0.05}	174.5	203	428	500
	(280SD) 280S	150	150	120	F	7	(1008) 1068	(484) 544	524	(364) 363	550	-	-	92	100	795	280 ^{0.10}	184	228.5	501	550
	(280MD) 280M	175	175	150	F	7	(1008) 1068	(509.5) 569.5	498.5	(389.5) 388.5	550	-	-	92	100	795	280 ^{0.10}	209.5	228.5	501	550
	315S	-	-	175	F	7	1178	589	589	408	633	-	-	92	125	865	315 ^{0.10}	203	254	540	615

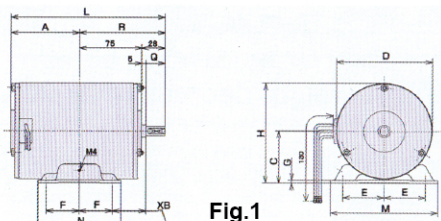

Fig.1

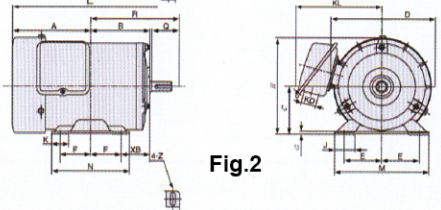

Fig.2

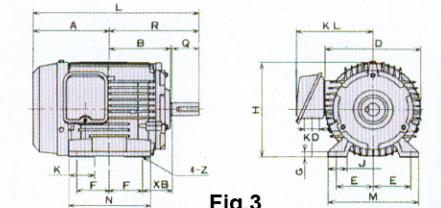

Fig.3

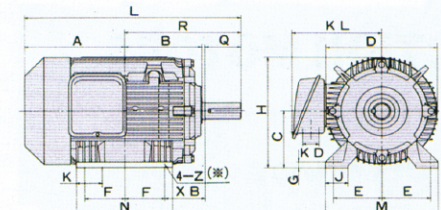

Fig.4

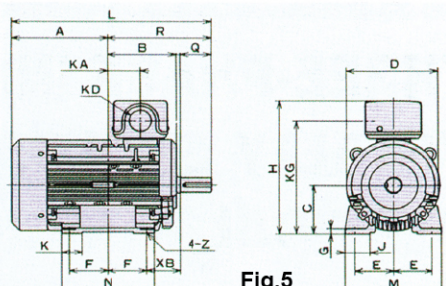

Fig.5

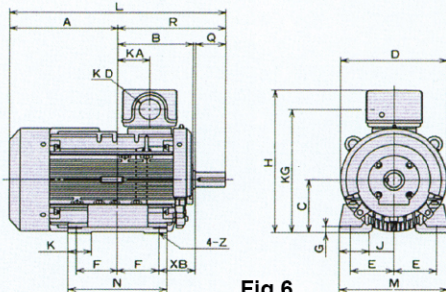

Fig.6

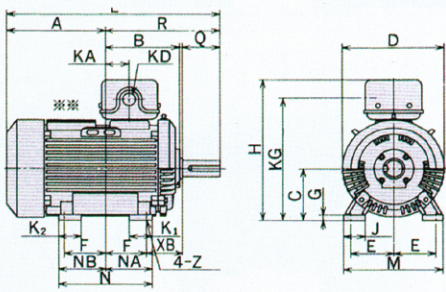
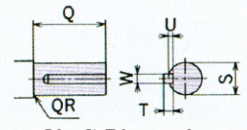

Fig.7



Shaft Dimension

Dimension in mm									Shaft Dimension Bearing No.		Approx Weight (kg)			Approx Packing Dimension (cm)
G	Z	XB	S	W	U	T	Q	QR	Drive end Side	Opposite Side	2pole	4pole	6pole	H x W x L
3.2	7x21	40	14 ⁺⁰ _{-0.011}	-	1	-	23	-	6202ZZ	6202ZZ	-	5	-	14.5 x 15 x 26
3.2	7x21	40	14 ⁺⁰ _{-0.011}	-	1	-	23	-	6202ZZ	6202ZZ	-	5.5	-	14.5 x 15 x 26
3.2	7x20	45	14 ^{+0.008} _{-0.003}	5	3	5	30	1	6203ZZ	6203ZZ	9.5	8.2	-	16 x 22 x 27
3.2	10x25	50	19 ^{+0.009} _{-0.004}	6	3.5	6	40	0.3	6204ZZ	6204ZZ	13.5	12.5	16	18 x 24 x 31
10	10	56	24 ^{+0.009} _{-0.004}	8	4	7	50	0.3	6205ZZ	6205ZZ	15.0 16.0	16.0	16	20 x 27 x 37
12.5	12	63	28 ^{+0.009} _{-0.004}	8	4	7	60	0.5	6206ZZ	6206ZZ	-	21	23	25 x 29 x 39
14	12	70	28 ^{+0.009} _{-0.004}	8	4	7	60	0.5	6306ZZ	6306ZZ	27.5	28	30	27 x 32 x 41
16	12	89	38 ^{+0.018} _{+0.002}	10	5	8	80	0.5	6308ZZ	6306ZZ	39.0 44.0	40	41	34.2 x 45.5 x 57.5
16	12	89	38 ^{+0.018} _{+0.002}	10	5	8	80	0.5	6308ZZ	6306ZZ	-	48	52	34.2 x 45.5 x 57.5
18	14.5	108	42 ^{+0.018} _{+0.002}	12	5	8	110	1	6309ZZ	6307ZZ	70 79	73	75	39 x 51 x 72.5
18	14.5	108	42 ^{+0.018} _{+0.002}	12	5	8	110	1	6309ZZ	6307ZZ	85	85	90	39 x 51 x 72.5
20	14.5	121	48 ^{+0.018} _{+0.002}	14	5.5	9	110	1.5	6311ZZ	6309ZZ	115	120 130	130	53 x 60 x 73
20	14.5	121	55 ^{+0.030} _{+0.011}	16	6	10	110	1.5	6312ZZ	6309ZZ	140	155	150 160	64 x 45 x 86
23	18.5	133	55 ^{+0.030} _{-0.011} 60 ^{+0.030} _{-0.011}	(16) 18	(6) 7	(10) 11	(110) 140	(-) 1.5	(6312) 6313ZZ	(6312ZZ) 6312ZZ	200 210	210 230	220 240	67 x 50 x 91
23	18.5	149	55 ^{+0.030} _{-0.011} 65 ^{+0.030} _{-0.011}	(16) 18	(6) 7	(10) 11	(110) 140	(-) 2.5	(6312) 6315ZZ	(6312ZZ) 6312ZZ	235	260	265	72 x 56 x 96
30	24	168	55 ^{+0.030} _{-0.011} 75 ^{+0.030} _{-0.011}	(16) 20	(6) 7.5	(10) 12	(110) 140	-	(6313C3) NU316	(6313C3) 6313ZZ	430	450	420	84 x 63 x 108
30	24	168	55 ^{+0.030} _{-0.011} 75 ^{+0.030} _{-0.011}	(16) 20	(6) 7.5	(10) 12	(110) 140	-	(6313C3) NU318	(6313C3) 6313ZZ	450	515	500	84 x 63 x 108
30	24	190	55 ^{+0.030} _{-0.011} 85 ^{+0.030} _{-0.011}	(16) 22	(6) 9	(10) 14	(110) 170	-	(6313C3) NU318	(6313C3) 6315ZZ	615	625	630	94 x 70 x 123
30	24	190	55 ^{+0.030} _{-0.011} 85 ^{+0.035} _{-0.013}	(16) 22	(6) 9	(10) 14	(110) 170	-	(6313C3) NU318	(6313C3) 6315ZZ	630	680	720	94 x 70 x 123
28	28	216	95 ^{+0.035} _{+0.013}	25	9	14	170	-	NU320	6318	-	-	930	97 x 73 x 134

Three-Phase Induction Motors

Totally Enclosed Fan-Cooled Type (TEFC)
 IP55 Series / Foot Mount Type [TFO-K(KK)]
 1/2~175HP (0.4~132kW)



Model:

xxHP or kW TFO-K(KK) xP IP55

Output

No of pole

Item	Specifications	
Motor Output	1/4~175HP (0.2~132kW)	
Rating	Continuous [S1]	
Number of pole	2, 4, 6 pole [8 Pole : only some range]	
Insulation Class	F Type	
Enclosure	IP55 (Outdoor use)	
Voltage, Frequency	Consult to nearest representative	
Number of Cable	~5HP : 6 Wires (Direct starting 220V or 380V)	
	7.5 HP ~ : 6 Wires (Star λ - Δ Delta Starting)	
	2 pole 30 HP ~ 4 pole 40 HP ~ 6 pole 50 HP ~	12 Wires (Star λ - Δ Delta Starting)
Color	Alcron gray	
Rotation	CCW (View from motor drive end)	
Environment	Temperature Humidity Altitude	-30 ~ 40°C Enclosed type Max 95% RH Max 1,000 m

DIMENSIONS (in mm)

Type From	Frame size	Out Put(HP)			Insulation	Fig. No	Dimension in mm														
		2pole	4pole	6pole			L	R	A	B	D	KD	K	J	H	C	F	E			
TFO-K	71M	0.4	0.4	-	F	1	239	120	119	90	145	PF 3/4	25	30	225	71 ϕ_s	45	56			
	80M	0.75	0.75	0.4	F	1	271.5	140	131.5	100	163	PF 3/4	25	35	240	80 ϕ_s	50	62.5			
	90L	1.5	2.2	1.5	0.75	F	2	320	168.5	151.5	118.5	180	PF 3/4	49	35.5	258	90 ϕ_s	62.5	70		
	100L	-	2.2	1.5	1.5	F	2	361	193	168	133	199	PF 1	51.5	45	258	100 ϕ_s	70	80		
	112M	3.7	3.7	2.2	2.2	F	2	377	200	177	140	223	PF 1	51.5	45	301	112 ϕ_s	70	95		
TFO-KK	132S	5.5	7.5	5.5	3.7	F	3	431.5	239	192.5	158	252	PF 1 1/4	56	50	359.5	132 ϕ_s	70	108		
	132M	-	7.5	5.5	5.5	F	3	469.5	258	211.5	177	252	PF 1 1/4	56	50	359.5	132 ϕ_s	89	108		
	160M	11	15	11	7.5	F	3	599	323	276	213	292	PF 1 1/2	107	60	413.5	160 ϕ_s	105	127		
	160L	18.5	15	11	11	F	3	599	345	254	225	292	PF 1 1/2	107	60	413.5	160 ϕ_s	127	127		
	180M	22	18.5	22	15	F	4	644	348.5	295.5	238.5	340	PF 1 1/2	75	90	462	180 ϕ_s	120.5	139.5		
TFO-KK	180L	30	30	18.5	22	F	5	717	367.5	349.5	257.5	340	PF 1 1/2	75	90	494	180 ϕ_s	139.5	139.5		
	(200LB) 200L	37	45	37	45	30	37	F	5	(794) 824	(395.5) 425.5	398.5	(276.5) 285.5	389.2	PF 2 1/2	85	110	541.5	200 ϕ_s	152.5	159
	(225SB) 225S	55	55	45	45	F	5	(830.5) 860.5	(402) 432	428.5	(283) 285.5	389.2	PF 2 1/2	85	110	566.5	225 ϕ_s	143	178		
	(250SD) 250M	75	75	55	55	F	6	(913) 943	(433.5) 463.5	479.5	(313.5) 312.5	520	PF 2 1/2	-	100	745	250 ϕ_s	155.5	203		
	(250MD) 250M	90	90	75	75	F	6	(913) 943	(452.5) 482.5	460.5	(332.5) 331.5	520	PF 2 1/2	-	100	745	250 ϕ_s	174.5	203		
	(280SD) 280S	110	110	90	90	F	6	(1016) 1072	(484) 544	(532) 528	(364) 363	575	PF 3	-	100	805	280 $\phi_{1.0}$	184	228.5		
	(280MD) 280M	132	132	110	110	F	6	(1016) 1072	(507.5) 569.5	(506.5) 502.5	(389.5) 388.5	575	PF 3	-	100	805	280 $\phi_{1.0}$	209.5	228.5		
	315S	-	-	-	132	F	6	1182	589	593	408	633	PF 3	-	125	865	315 $\phi_{1.0}$	203	254		

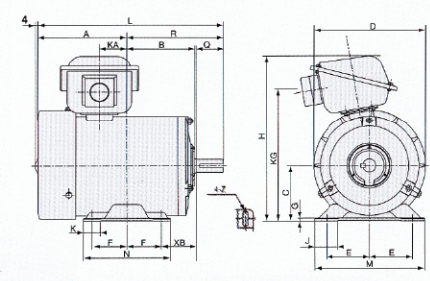
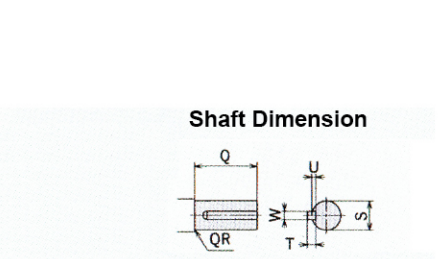
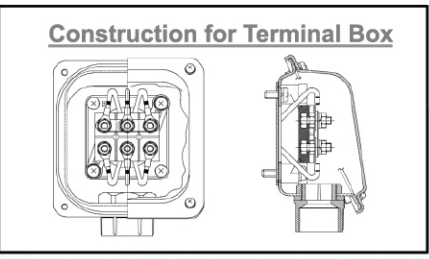
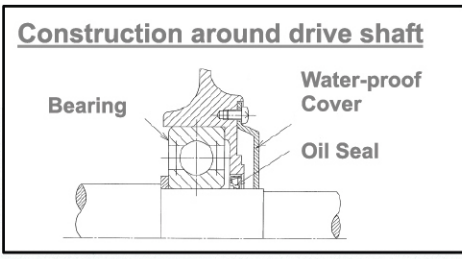

Fig.1

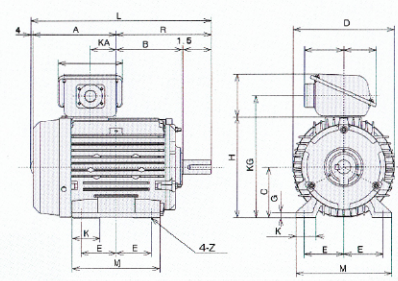

Fig.2

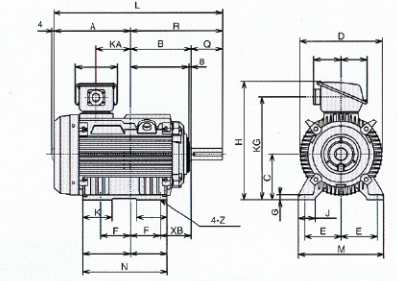

Fig.3

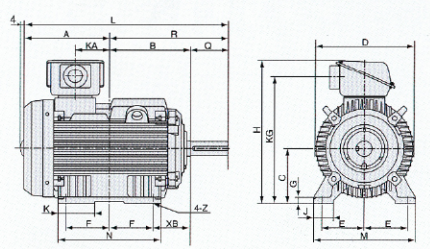

Fig.4

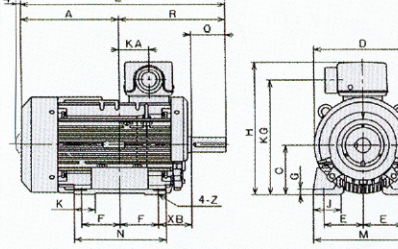

Fig.5

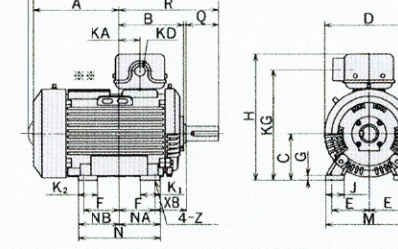

Fig.6

Dimension in mm											Approx Weight (kg)			Approx Packing Dimension (cm)
N	M	G	Z	XB	S	W	U	T	Q	QR	2pole	4pole	6pole	H x W x L
115	140	3.2	7x20	45	14 ^{+0.008} _{-0.003}	5	3	5	30	1	9.5	8.2	-	29 x 19 x 30
125	160	3.2	10x25	50	19 ^{+0.009} _{-0.004}	6	3.5	6	40	0.3	13.5	12.5	16	30 x 20 x 34
155	170	10	10	56	24 ^{+0.009} _{-0.004}	8	4	7	50	0.3	15 16	16	16	32 x 23 x 39
175	195	12.5	12	63	28 ^{+0.009} _{-0.004}	8	4	7	60	0.5	-	21	23	36 x 30 x 40
175	224	14	12	70	28 ^{+0.009} _{-0.004}	8	4	7	60	0.5	27.5	28	30	36 x 32 x 41
175	250	16	12	89	38 ^{+0.018} _{+0.002}	10	5	8	80	0.5	39 44	40	41	42 x 35 x 52
212	250	16	12	89	38 ^{+0.018} _{+0.002}	10	5	8	80	0.5	-	48	52	42 x 35 x 56
300	300	18	14.5	108	42 ^{+0.018} _{+0.002}	12	5	8	110	1	70 79	73	75	50 x 51 x 66
300	300	18	14.5	108	42 ^{+0.018} _{+0.002}	12	5	8	110	1	85	85	90	50 x 51 x 66
300	350	20	14.5	121	48 ^{+0.018} _{+0.002}	14	5.5	9	110	1.5	115	120 130	130	61 x 45 x 73
335	350	20	14.5	121	55 ^{+0.030} _{-0.011}	16	6	10	110	1.5	145	160	155 165	64 x 45 x 86
365	400	23	18.5	133	60 ^{+0.030} _{+0.011}	(16) 18	(6) 7	(10) 11	(110) 140	(-) 1.5	205 215	215 235	225 245	67 x 50 x 94
350	450	23	18.5	149	65 ^{+0.030} _{-0.011}	(16) 18	(6) 7	(10) 11	(110) 140	(-) 2.5	240	265	270	72 x 56 x 96
420	500	30	24	168	75 ^{+0.030} _{-0.011}	(16) 20	(6) 7.5	(10) 12	(110) 140	-	470	490	475	85 x 62 x 112
420	500	30	24	168	75 ^{+0.030} _{-0.011}	(16) 20	(6) 7.5	(10) 12	(110) 140	-	490	535	555	85 x 62 x 112
490	550	30	24	190	85 ^{+0.030} _{-0.011}	(16) 22	(6) 9	(10) 14	(110) 170	-	630	645	685	92 x 67 x 122
490	550	30	24	190	85 ^{+0.030} _{-0.011}	(16) 22	(6) 9	(10) 14	(110) 170	-	675	725	745	92 x 67 x 122
540	615	28	28	216	95 ^{+0.035} _{+0.013}	25	9	14	170	-	-	-	930	97 x 73 x 134

Three-Phase Induction Motors

Totally Enclosed Fan-Cooled Type (TEFC)

IP44 Series / Flange Type (Vertical Type) [VTFO-K(KK)]

1/7~175HP (0.1~132kW)



Model:

xxHP or kW VTFO-K(KK) xP IP44

Output

No of pole

Item	Specifications	
Motor Output	1/4~175HP (0.2~132kW)	
Rating	Continuous [S1]	
Number of pole	2, 4, 6 pole [8 Pole : only some range]	
Insulation Class	B Type	~180 M
	F Type	180 L~
Enclosure	IP44 (Outdoor type is also available)	
Voltage, Frequency	Consult to nearest representative	
Number of Cable	~5 HP 6 Wires (Direct starting 220V or 380V)	
	7.5 HP ~ 6 Wires (Star Δ - Δ Delta Starting)	
	2 pole 30 HP ~	12 Wires (Star Δ - Δ Delta Starting)
	4 pole 40 HP ~	
6 pole 50 HP ~		
Color	Alcron gray	
Rotation	CCW (View from motor drive end)	
Environment	Temperature	-30 ~ 40 °C
	Humidity	Enclosed type Max 95% RH
	Altitude	Max 1,000 m

DIMENSIONS (in mm)

Type From	Flange size	Frame size	Out Put(HP)			Insulation	Fig. No	Dimension in mm							
			2pole	4pole	6pole			LA	LB	LC	LE	LG	LZ	D	
VTO-K	FF130	63M	-	1/7 1/4	-	B	1	130	110	+0.013 -0.009	160	3.5	8	10	130
VTFO-K	FF130	71M	1/2	1/2	-	B	2	130	110	+0.013 -0.009	160	3.5	10	10	145
	FF165	80M	1	1	1/2	B	2	165	130	+0.014 -0.011	200	3.5	12	12	163
		90M	2 3	2	1	B	3	165	130	+0.014 -0.011	200	3.5	12	12	180
	FF215	100M	-	3	2	B	4	215	180	+0.014 -0.011	250	4	16	14.5	199
112M		5	5	3	B	4	215	180	+0.014 -0.011	250	4	16	14.5	223	
VTFO-KK	FF265	132S	7.5 10	7.5	5	B	5	265	230	+0.016 -0.013	300	4	20	14.5	250
		132M	-	10	7.5	B	5	265	230	+0.016 -0.013	300	4	20	14.5	250
	FF300	160M	15 20	15	10	B	5	300	250	+0.016 -0.013	350	5	20	18.5	290
		160L	25	20	15	B	5	300	250	+0.016 -0.013	350	5	20	18.5	290
FF350	180M	30	25 30	20	B	5	350	300	+0.016 -0.016	395	5	20	18.5	340	
VTFO-KK	FF350	180L	40	40	25 30	F	5	350	300	+0.016 -0.016	395	5	20	18.5	340
	FF400	(200LB) 200L	50 60	50 60	40 50	F	6	400	350	+0.018 -0.018	445	5	22	18.5	391
		(225SB) 225S	75	75	60	F	6	500	450	+0.020 -0.020	545	5	22	18.5	391
	FF500	(250MD) 250M	100 120	100 120	75 100	F	7	500	450	+0.020 -0.020	545	5	22	18.5	490
		(280MD) 280M	150 175	150 175	120 150	F	7	600	550	+0.022 -0.022	655	6	25	24	550
	FF600	315M	-	-	175	F	7	600	550	+0.022 -0.022	655	6	25	24	633

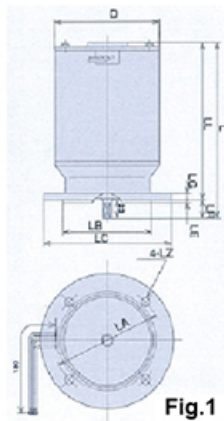

Fig.1

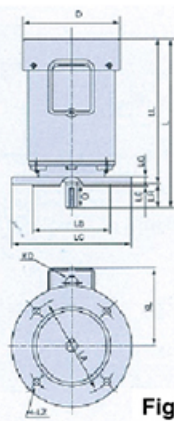

Fig.2

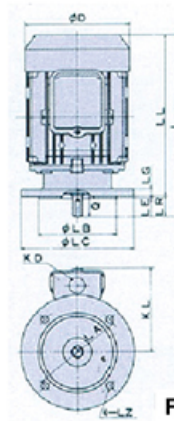

Fig.3

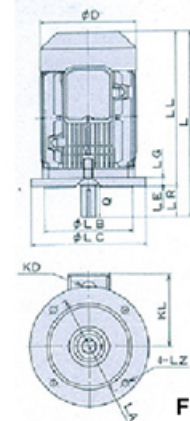

Fig.4

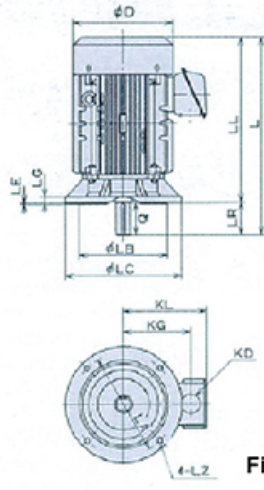

Fig.5

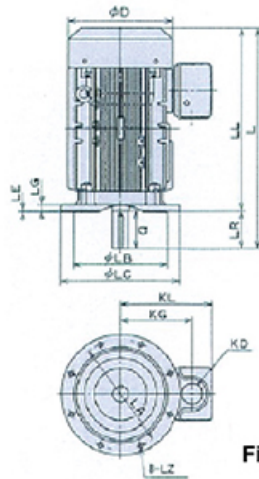

Fig.6

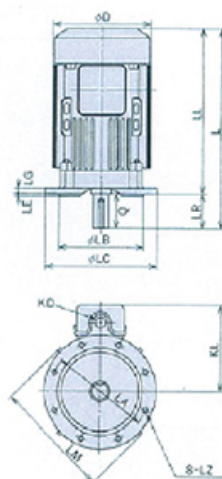

Fig.7

Dimension in mm												Bearing No.		Approx Weight (kg)			Approx Packing Dimension (cm)
L	LL	KL	KD	LR	S	W	U	T	Q	QR	Drive end Side	Opposite Side	2pole	4pole	6pole	H x W x L	
219	196	-	-	23	11 ⁺⁰ _{-0.011}	-	1	-	23	-	6202ZZ	6202ZZ	6.9	-	-	23 x 21.5 x 31.5	
256	226	123	22	30	14 ^{+0.008} _{-0.003}	5	3	5	30	1	6203ZZ	6203ZZ	10.5	9	-	32 x 25 x 28	
283	243	131	22	40	19 ^{+0.009} _{-0.004}	6	3.5	6	40	0.3	6204ZZ	6204ZZ	15.5	14.4	17.5	34 x 30 x 32	
324	274	145	22	50	24 ^{+0.009} _{-0.004}	8	4	7	50	0.3	6205ZZ	6205ZZ	17	18	17	40 x 30 x 33	
356	296	153	28	60	28 ^{+0.009} _{-0.004}	8	4	7	60	0.5	6206ZZ	6206ZZ	-	24	25	41 x 35 x 37	
372	312	166.5	28	60	28 ^{+0.009} _{-0.004}	8	4	7	60	0.5	6306ZZ	6306ZZ	30	32	32	47 x 35 x 37	
427.5	347.5	197	36	80	38 ^{+0.018} _{+0.002}	10	5	8	80	0.5	6308ZZ	6306ZZ	43	44	45	55 x 41 x 43	
465.5	385.5	197	36	80	38 ^{+0.018} _{+0.002}	10	5	8	80	0.5	6308ZZ	6306ZZ	-	52	57	59 x 41 x 43	
595	485	256	52	110	42 ^{+0.018} _{+0.002}	12	5	8	110	1.0	6309ZZ	6307ZZ	83	85	82	70 x 42 x 52	
595	485	256	52	110	42 ^{+0.018} _{+0.002}	12	5	8	110	1.0	6309ZZ	6307ZZ	90	90	96	70 x 42 x 52	
670	560	279	52	110	48 ^{+0.018} _{+0.002}	14	5.5	9	110	1.0	6312ZZ	6309ZZ	130	130	140	80 x 50 x 56	
743	633	314	52	110	55 ^{+0.030} _{+0.011}	16	6	10	110	1.5	6312ZZ	6309ZZ	140	165	160	87 x 50 x 59	
(790)	680	341.5	52	(110)	(55 ^{+0.030} _{-0.011})	(16)	(6)	(10)	(110)	(-)	(6312)	(6312ZZ)	210	220	230	(90 x 65 x 64)	
820				140	60 ^{+0.030} _{-0.011}	18	7	11	140	1.5	6313ZZ	6312ZZ	220	240	250	93 x 53 x 64	
(826.5)	716.5	341.5	78	(110)	(55 ^{+0.030} _{-0.011})	(16)	(6)	(10)	(110)	(-)	(6312)	(6312ZZ)	245	270	275	(93 x 65 x 68)	
856.5				140	65 ^{+0.030} _{-0.011}	18	7	11	140	2.5	6315ZZ	6312ZZ	245	270	275	96 x 65 x 68	
(909)	799	485	78	(110)	(55 ^{+0.030} _{-0.011})	(16)	(6)	(10)	(110)	-	(6313C3)	(6313C3)	470	490	490	(103 x 71 x 91)	
939				140	75 ^{+0.030} _{-0.011}	20	7.5	12	140	-	6316	6313ZZ	490	540	550	106 x 71 x 91	
(1012)	(902)	515	92	(110)	(55 ^{+0.030} _{-0.011})	(16)	(6)	(10)	(110)	-	(6313C3)	(6313C3)	660	675	680	(113 x 81 x 100)	
1068	898			170	85 ^{+0.035} _{-0.013}	22	9	14	170	-	6318	6315ZZ	680	730	750	119 x 81 x 100	
1228	1058	550	92	170	95 ^{+0.035} _{-0.013}	25	9	14	170	-	6320	6318	-	-	980	135 x 96 x 110	

Three-Phase Induction Motors

Totally Enclosed Fan-Cooled Type (TEFC)

IP55 Series / Flange Type (Vertical Type) [VTFO-K(KK)]

1/2~175HP (0.4~132kW)



Model:

xxHP or kW VTFO-K(KK) xP IP55

Output

No of pole

Item	Specifications	
Motor Output	1/2 ~ 175HP (0.4 ~ 132kW)	
Rating	Continuous [S1]	
Number of pole	2, 4, 6 pole [8 Pole : only some range]	
Insulation Class	F Type	
Enclosure	IP55 (Outdoor use)	
Voltage, Frequency	Consult to nearest representative	
Number of Cable	~5 HP : 6 Wires (Direct starting 220V or 380V)	
	7.5HP ~ : 6 Wires (Star Δ - Δ Delta Starting)	
	2 pole 30 HP ~ 4 pole 40 HP ~ 6 pole 50 HP ~	12 Wires (Star Δ - Δ Delta Starting)
Color	Alcron gray	
Rotation	CCW (View from motor drive end)	
Environment	Temperature Humidity Altitude	-30 ~ 40 °C Enclosed type Max 95% RH Max 1,000 m

DIMENSIONS (in mm)

Type From	Flange size	Frame size	Out Put(kw)			Insulation	Flg. No	Dimension in mm							
			2pole	4pole	6pole			LA	LB	LC	LE	LG	LZ	D	
VTFO-K	FF130	71M	0.4	0.4	-	F	1	130	110	+0.013 -0.009	160	3.5	10	10	145
	FF165	80M	0.75	0.75	0.4	F	1	165	130	+0.014 -0.011	200	3.5	12	12	163
		90L	1.5 2.2	1.5	0.75	F	2	165	130	+0.014 -0.011	200	3.5	12	12	180
	FF215	100L	-	2.2	1.5	F	2	215	180	+0.014 -0.011	250	4	16	14.5	199
112M		3.7	3.7	2.2	F	3	215	180	+0.014 -0.011	250	4	16	14.5	223	
VTFO-KK	FF265	132S	5.5 7.5	5.5	3.7	F	4	265	230	+0.014 -0.011	300	4	20	14.5	250
		132M	-	7.5	5.5	F	4	265	230	+0.016 -0.013	300	4	20	14.5	250
	FF300	160M	11 15	11	7.5	F	4	300	250	+0.016 -0.013	350	5	20	18.5	290
		160L	18.5	15	11	F	4	300	250	+0.016 -0.013	350	5	20	18.5	290
	FF350	180M	22	18.5 22	15	F	5	350	300	+0.016 -0.016	395	5	20	18.5	340
VTFO-KK	FF350	180L	30	30	18.5 22	F	5	350	300	+0.016 -0.016	395	5	20	18.5	340
	FF400	(200LB) 200L	37 45	37 45	30 37	F	(7) 6	400	350	+0.018 -0.018	445	5	22	18.5	391
		(225SB) 225S	55	55	45	F	(7) 6	500	450	+0.020 -0.020	545	5	22	18.5	391
	FF500	(250MD) 250M	75 90	75 90	55 75	F	8	500	450	+0.020 -0.020	545	5	22	18.5	490
		(280MD) 280M	110 132	110 132	90 110	F	8	600	550	+0.022 -0.022	655	6	25	24	550
	FF600	315M	-	-	132	F	8	600	550	+0.022 -0.022	655	6	25	24	633

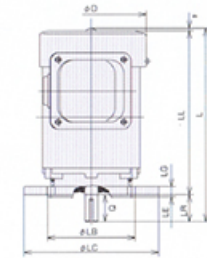

Fig.1

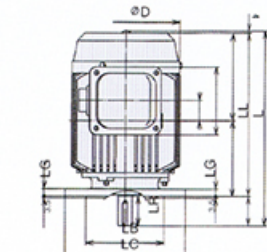

Fig.2

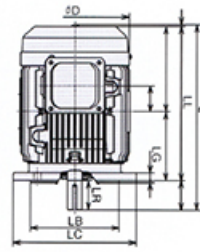

Fig.3

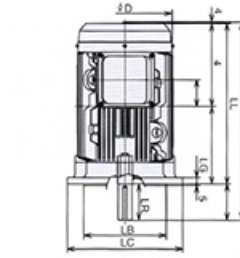

Fig.4

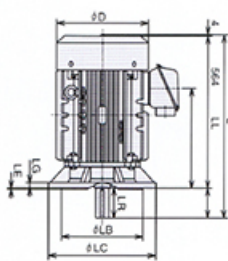

Fig.5

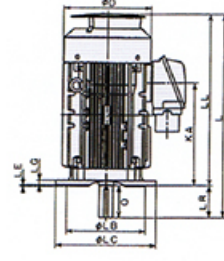

Fig.6

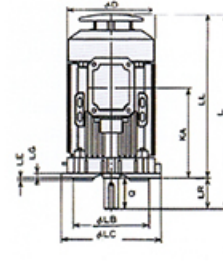

Fig.7

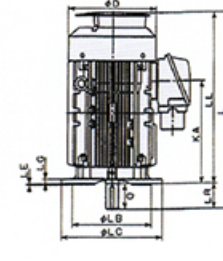
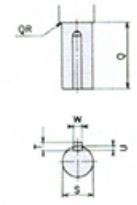

Fig.8



Shaft Dimension

Dimension in mm										Approx Weight (kg)			Approx Packing Dimension (cm)
LL	KD	KL	LR	S	W	U	T	Q	QR	2pole	4pole	6pole	H x W x L
230	PF 3/4	148	30	14 ^{+0.008} / _{-0.003}	5	3	5	30	1	10.5	9	-	32 x 25 x 28
247	PF 3/4	156	40	19 ^{+0.009} / _{-0.004}	6	3.5	6	40	0.3	15.5	14.4	17.5	34 x 30 x 32
277	PF 3/4	168	50	24 ^{+0.009} / _{-0.004}	8	4	7	50	0.3	17 18	18	17	40 x 30 x 33
300	PF 1	176	60	28 ^{+0.009} / _{-0.004}	8	4	7	60	0.5	-	24	25	41 x 35 x 37
316	PF 1	166.5	60	28 ^{+0.009} / _{-0.004}	8	4	7	60	0.5	30	32	32	47 x 35 x 37
351.5	PF 1 1/4	197	80	38 ^{+0.018} / _{+0.002}	10	5	8	80	0.5	43 48	44	45	55 x 41 x 43
389.5	PF 1 1/4	197	80	38 ^{+0.018} / _{+0.002}	10	5	8	80	0.5	-	52	57	59 x 41 x 43
489	PF 1 1/2	259.5	110	42 ^{+0.018} / _{+0.002}	12	5	8	110	1.0	83 89	85	82	70 x 42 x 52
489	PF 1 1/2	259.5	110	42 ^{+0.018} / _{+0.002}	12	5	8	110	1.0	90	90	96	70 x 42 x 52
564	PF 2	282.5	110	48 ^{+0.018} / _{+0.002}	14	5.5	9	110	1.0	130	130 140	140	80 x 50 x 56
637	PF 2 1/2	317.5	110	55 ^{+0.030} / _{+0.011}	16	6	10	110	1.5	140	165	160 170	87 x 50 x 59
680	PF 2 1/2	341.5	(110) 140	(55 ^{+0.030} / _{-0.011}) 60 ^{+0.030} / _{-0.011}	(16) 18	(6) 7	(10) 11	(110) 140	(-) 1.5	210 220	220 240	230 250	(90 x 65 x 64) 93 x 53 x 64
716.5	PF 2 1/2	341.5	(110) 140	(55 ^{+0.030} / _{-0.011}) 65 ^{+0.030} / _{-0.011}	(16) 18	(6) 7	(10) 11	(110) 140	(-) 2.5	245	270	275	(93 x 65 x 68) 96 x 65 x 68
799	PF 2 1/2	485	(110) 140	(55 ^{+0.030} / _{-0.011}) 75 ^{+0.030} / _{-0.011}	(16) 20	(6) 7.5	(10) 12	(110) 140	-	470 490	490 540	490 550	(103 x 71 x 91) 106 x 71 x 91
(902) 898	PF 3	515	(110) 170	(55 ^{+0.030} / _{-0.011}) 85 ^{+0.030} / _{-0.011}	(16) 22	(6) 9	(10) 14	(110) 170	-	660 680	675 730	680 750	(113 x 81 x 100) 119 x 81 x 100
1058	PF 3	550	170	95 ^{+0.035} / _{+0.013}	25	9	14	170	-	-	-	980	135 x 96 x 110

Characteristics and Performance of Three Phase Motor

1. The figures are reference data. If you need guaranteed performance data, please contact (Sales agent)
2. Only torque (full-load, starting, maximum, accelerating) and starting current are actual measurement value. Other data are equivalent circuit measures.
3. Not only current but also other characteristics may be changed under different voltage specifications. Please contact (Sales agent), if required any clarification.

2 pole

50Hz

Rated Output		Volt	Hz	Rated Speed (min ⁻¹)	Torque			Current				Efficiency			Power Factor			Moment of Inertia J (kg - m ²)
HP	kW				Rated	Start	Max	50%	75%	100%	Start	50%	75%	100%	50%	75%	100%	
					(Nm)	(%)	(%)	(A)	(A)	(A)	(A)	(%)	(%)	(%)	(%)	(%)	(%)	
1/2	0.4	220	50	2910	1.34	265	295	1.3	1.5	1.8	11.0	68.0	72.5	73.5	61.5	74.5	83.5	0.000875
		380		2910	1.34	265	295	0.75	0.84	1.0	6.5	68.0	72.5	73.5	61.5	74.5	83.5	
		415		2920	1.33	320	350	0.82	0.90	1.0	7.0	63.0	69.0	71.5	54.0	67.0	76.5	
1	0.75	220	50	2900	2.51	210	275	1.9	2.4	3.0	19.0	76.0	78.0	77.5	67.0	79.5	66.0	0.000973
		380		2900	2.51	210	275	1.1	1.4	1.7	11.0	76.0	78.0	77.5	67.0	79.5	66.0	
		415		2900	2.49	255	335	1.3	1.5	1.7	12.0	71.5	76.0	77.0	58.0	71.0	70.5	
2	1.5	220	50	2900	5.03	220	260	3.3	4.3	5.4	33.0	80.5	81.5	80.5	73.5	84.0	89.5	0.00170
		380		2900	5.03	220	260	1.9	2.5	3.1	19.0	80.5	81.5	80.5	73.5	84.0	89.5	
		415		2900	5.05	265	310	2.1	2.5	3.0	21.0	78.0	81.0	81.0	64.0	76.5	84.0	
3	2.2	220	50	2850	7.41	300	280	5.0	6.3	8.0	61.0	83.5	84.0	83.0	70.0	82.0	87.5	0.00180
		380		2860	7.41	300	290	2.9	3.5	4.6	35.0	83.5	84.0	83.0	70.0	82.0	87.5	
		415		2870	7.34	370	355	3.5	4.0	4.8	39.0	79.5	82.0	82.0	55.5	69.5	76.0	
5	3.7	220	50	2860	12.4	270	300	7.1	9.7	12.5	90.0	84.0	85.0	84.5	81.5	88.5	91.5	0.00520
		380		2880	12.4	270	300	4.1	5.6	7.2	52.0	84.0	85.0	84.5	81.5	88.5	91.5	
		415		2890	12.7	335	375	4.5	5.7	6.9	58.0	82.0	84.0	84.5	69.5	80.0	66.0	
7.5	5.5	380	50	2890	17.9	250	300	5.8	8.1	10.7	76.0	87.5	88.5	88.5	81.0	87.0	89.5	0.00920
		415		2900	17.8	310	380	6.4	8.1	10.7	85.0	86.0	88.0	88.5	70.0	80.0	85.0	
10	7.5	380	50	2900	24.3	240	275	7.7	10.7	14.0	105.0	88.5	90.0	89.5	83.5	89.0	90.5	0.0111
		415		2910	24.2	300	345	8.2	10.7	13.7	120.0	87.0	89.5	89.5	73.0	82.0	86.5	
15	11	380	50	2900	35.7	280	295	11.7	16.0	21	150.0	90.5	90.0	90.0	80.5	87.0	89.5	0.0193
		415		2910	36.6	320	365	13.2	16.6	21	165.0	89.0	89.0	89.5	66.5	77.5	83.0	
20	15	380	50	2900	49.0	300	325	15.8	21.5	28	210.0	90.5	91.0	90.5	80.0	87.5	89.5	0.0234
		415		2910	48.8	375	410	17.9	22.5	28	235.0	89.0	90.5	90.5	66.5	77.0	82.5	
25	18.5	380	50	2910	59.9	300	320	18.0	26.2	34	260.0	90.5	91.5	91.5	81.5	88.0	90.5	0.0264
		415		2930	59.8	375	395	21.5	27.2	34	280.0	83.0	91.0	91.0	87.0	78.0	83.5	
30	22	380	50	2920	71.0	280	330	23.5	31.8	41	320.0	89.5	91.0	91.0	76.5	86.5	89.5	0.0537
		415		2920	70.8	340	405	26.6	33.1	41	350.0	87.0	89.5	90.5	66.0	77.0	83.5	
40	30	380	50	2920	97.6	245	290	30.0	42.0	55	385.0	89.0	90.0	89.5	85.5	90.5	92.0	0.0613
		415		2930	97.3	290	335	33.2	42.9	54	420.0	87.5	89.5	89.5	72.0	81.5	86.0	
50	37	380	50	2930	120	230	230	37.3	52.4	69	445.0	88.5	90.0	90.5	85.0	89.0	90.0	0.111
		415		2940	120	30	280	40.7	53.1	67	490.0	87.5	90.0	90.5	72.0	81.0	84.5	
60	45	380	50	2920	146	250	245	45.9	63.5	84	575.0	88.5	90.0	90.5	85.0	89.5	90.5	0.120
		415		2930	146	305	300	49.1	64.0	81	635.0	88.0	90.0	90.5	72.5	81.5	85.5	
75	55	380	50	2920	178	275	270	53.8	76.0	100	730.0	90.5	92.0	91.5	85.5	90.0	91.0	0.140
		415		2940	178	340	340	58.8	76.8	93	805.0	90.0	91.5	91.5	72.5	81.5	85.5	

Rated Output	Volt	Hz	Rated Speed (min ⁻¹)	Torque			Current				Efficiency			Power Factor			Moment of Inertia J (kg - m ²)	
				Rated (Nm)	Start (%)	Max (%)	50% (A)	75% (A)	100% (A)	Start (A)	50% (%)	75% (%)	100% (%)	50% (%)	75% (%)	100% (%)		
HP	kW																	
1/2	0.4	220	50	1410	2.77	245	260	1.4	1.6	1.9	8.0	70.0	73.0	72.5	55.5	69.5	79.0	0.000073
		380		1410	2.77	245	260	0.78	0.90	1.1	4.5	70.0	73.0	72.5	55.5	69.5	79.0	
		415		1425	2.72	300	320	0.88	1.0	1.1	5.0	66.5	70.5	72.0	48.0	61.0	71.0	
1	0.75	220	50	1410	5.10	220	265	1.9	2.4	3.0	15.0	79.0	80.0	78.0	64.5	76.5	83.0	0.000213
		380		1410	5.10	220	265	1.1	1.4	1.7	8.5	79.0	80.0	78.0	64.5	76.5	83.0	
		415		1425	5.03	270	330	1.2	1.4	1.7	9.5	76.5	79.0	78.5	67.0	70.0	78.0	
2	1.5	220	50	1420	10.3	225	250	4.0	4.9	6.1	31.0	79.5	80.5	78.0	61.5	74.5	82.0	0.00330
		380		1420	10.3	225	250	2.3	2.9	3.5	18.0	79.5	80.5	78.0	61.5	74.5	82.0	
		415		1435	10.2	275	305	2.6	3.0	3.5	20.0	76.5	79.0	78.5	51.5	65.5	74.5	
3	2.2	220	50	1430	15.1	230	250	5.5	6.9	8.5	48.0	82.5	82.5	80.5	64.0	76.5	83.0	0.00570
		380		1430	15.1	230	250	3.2	4.0	4.9	28.0	82.5	82.5	80.5	64.0	76.5	83.0	
		415		1440	14.9	280	310	3.6	4.2	4.8	31.0	80.0	82.0	81.0	64.0	67.5	76.0	
5	3.7	220	5	1410	25.4	220	240	8.4	10.8	13.8	80.0	84.5	84.0	81.5	69.0	80.0	85.5	0.0110
		380		1410	25.4	220	240	4.8	6.3	8.0	45.0	84.5	84.0	81.5	69.0	80.0	85.5	
		415		1430	25.1	270	300	5.5	6.6	8.0	52.0	81.5	83.0	82.0	57.0	70.5	78.5	
7.5	5.5	380	50	1435	36.1	240	290	6.7	8.8	11.5	67.0	87.5	86.0	87.0	70.5	81.0	86.0	0.0171
		415		1440	35.9	266	345	7.5	9.1	11.5	73.0	85.5	87.0	87.0	59.5	72.5	80.0	
10	7.5	380	50	1430	49.1	275	295	9.0	11.8	15.5	98.0	88.5	89.0	88.0	71.5	82.0	86.5	0.0214
		415		1440	48.9	335	365	9.9	12.1	15.5	105.0	86.5	88.0	88.0	61.0	73.5	80.5	
15	11	380	50	1440	71.8	240	265	12.9	17.1	22	135.0	88.5	89.0	88.0	73.0	82.0	85.0	0.0345
		415		1450	71.5	285	315	14.6	17.9	22	145.0	88.0	88.0	88.0	61.0	73.0	79.5	
20	15	380	50	1450	98.3	260	295	17.2	22.8	29	195.0	90.5	90.5	89.5	73.5	82.5	86.5	0.0446
		415		1450	97.8	316	355	19.3	23.7	29	216.0	99.0	88.5	89.0	61.5	74.0	80.5	
25	18.5	380	50	1455	121	245	265	21.5	29.4	37	240.0	99.0	90.0	89.6	73.5	82.5	85.5	0.0875
		415		1455	120	295	320	25.0	30.3	37	266.0	85.5	88.5	89.0	59.5	72.0	78.5	
30	22	380	50	1455	143	275	300	24.9	33.2	43	306.0	90.0	91.0	90.5	74.5	83.0	86.5	0.101
		415		1460	142	335	370	27.9	34.5	43	340.0	88.0	80.0	90.5	62.0	74.0	80.0	
40	30	380	50	1450	196	275	310	33.1	44.5	58	420.0	90.5	91.0	90.5	76.0	84.5	87.5	0.127
		415		1450	195	340	385	36.9	46.0	57	465.0	89.5	90.5	90.5	63.5	75.0	81.0	
50	37	380	50	1450	240	245	270	40.8	55.0	72	470.0	90.5	91.5	91.0	78.0	84.0	88.5	0.208
		415		1460	239	300	335	44.8	56.1	70	520.0	89.5	91.0	91.0	64.5	75.5	81.0	
60	45	380	50	1450	292	235	265	48.5	66.0	86	570.0	91.0	92.0	91.5	77.0	84.5	87.0	0.230
		415		1465	292	285	330	53.0	67.1	84	630.0	90.0	91.5	91.5	65.5	76.5	81.5	
75	55	380	50	1455	356	280	275	60.2	81.1	105	735.0	92.0	93.0	92.5	75.0	83.5	86.5	0.280
		415		1460	355	340	340	70.1	86.3	107	810.0	90.5	92.0	92.5	60.0	72.0	78.5	
100	75	380	50	1470	466	295	300	72.7	102.3	135	1124	92.0	93.0	93.0	85.5	80.0	91.5	1.00
		415		1475	484	365	375	72.6	97.9	130	1248	91.5	92.5	93.0	78.5	86.0	89.0	
120	90	380	50	1470	579	355	405	86.3	121.3	160	1547	93.5	94.5	94.5	85.0	89.5	91.0	1.25
		415		1475	578	440	505	86.3	116.3	150	1720	92.5	94.0	94.5	78.0	86.0	89.0	
150	110	380	50	1475	712	345	305	105.2	148.8	200	1548	93.0	94.0	93.5	85.0	89.5	91.0	1.96
		415		1480	710	430	380	104.4	141.9	185	1710	92.5	93.5	94.0	79.0	86.0	89.0	
175	132	380	50	1475	855	385	345	125.9	177.6	240	2002	93.5	94.0	94.0	85.0	90.0	91.5	2.30
		415		1480	852	480	410	123.8	168.4	220	2213	93.5	94.0	94.5	79.5	85.5	89.5	

6 pole

50Hz

Rated Output		Volt	Hz	Rated Speed	Torque			Current				Efficiency			Power Factor			Moment of Inertia J
					Rated	Start	Max	50%	75%	100%	Start	50%	75%	100%	50%	75%	100%	
HP	kW			(min ⁻¹)	(Nm)	(%)	(%)	(A)	(A)	(A)	(A)	(%)	(%)	(%)	(%)	(%)	(%)	(kg - m ²)
1/2	0.4	220	50	940	4.13	225	270	1.6	1.8	2.1	9.0	66.5	70.5	70.5	49.0	62.5	72.5	0.00215
		380		940	4.13	225	270	0.93	1.0	1.2	5.0	66.5	70.5	70.5	49.0	62.5	72.5	
		415		950	4.06	280	330	1.0	1.1	1.2	5.5	63.5	69.0	70.5	43.5	56.0	66.0	
1	0.75	220	50	930	7.97	220	240	2.9	3.2	3.8	15.0	68.5	71.0	69.5	50.5	64.0	73.5	0.00460
		380		930	7.97	220	240	1.7	1.9	2.2	8.5	68.5	71.0	69.5	50.5	64.0	73.5	
		415		940	7.97	260	285	1.9	2.0	2.3	9.5	64.0	69.0	69.5	43.5	56.0	66.0	
2	1.5	220	50	930	15.4	210	240	4.6	5.5	6.6	32.0	76.5	77.5	74.5	56.0	69.5	77.0	0.00870
		380		930	15.4	210	240	2.7	3.2	3.8	18.0	76.5	77.5	74.5	56.0	69.5	77.0	
		415		930	15.4	250	285	3.0	3.4	3.9	19.0	71.5	74.5	73.5	49.0	62.5	71.5	
3	2.2	220	50	940	22.5	260	270	6.2	7.4	9.4	52.0	80.0	81.5	80.0	58.5	72.0	79.5	0.0132
		380		940	22.5	260	270	3.6	4.3	5.4	30.0	80.0	81.5	80.0	58.5	72.0	79.5	
		415		950	22.2	325	340	4.0	4.5	5.4	33.0	77.0	80.0	80.0	50.0	63.5	72.5	
5	3.7	220	5	930	38.2	210	255	8.9	11.4	14.5	80.0	85.0	84.5	82.0	64.5	76.0	81.0	0.0256
		380		930	38.2	210	255	5.1	6.6	8.4	46.0	85.0	84.5	82.0	64.5	76.0	81.0	
		415		940	38.5	265	320	5.6	6.7	8.2	52.0	83.0	84.0	83.0	55.0	68.0	75.5	
7.5	5.5	380	50	940	54.9	265	285	7.6	9.7	12.7	71.0	88.0	88.0	86.5	62.5	73.5	78.5	0.0343
		415		950	54.5	315	340	8.6	10.2	12.6	77.0	85.0	87.0	86.5	52.5	65.0	72.0	
10	7.5	380	50	960	73.2	245	340	10.3	12.8	16.5	115.0	87.0	88.0	87.0	63.5	76.0	82.5	0.0551
		415		960	72.9	305	425	12.1	14.0	17.0	125.0	83.0	85.5	86.0	51.5	65.5	74.0	
15	11	380	50	960	108	250	345	13.7	17.6	23	160.0	89.0	89.0	88.0	68.5	80.0	85.0	0.0727
		415		960	107	310	430	15.3	18.4	23	175.0	86.5	88.0	88.0	57.5	71.0	78.5	
20	15	380	50	965	146	235	265	18.3	23.9	31	190.0	90.5	90.5	90.0	69.0	79.0	83.0	0.140
		415		965	145	285	315	20.8	25.1	31	205.0	87.0	89.0	89.0	57.5	70.0	76.5	
25	18.5	380	50	965	181	240	265	22.1	29.0	38	220.0	89.5	90.0	89.5	71.0	80.5	84.5	0.164
		415		965	180	295	325	24.6	30.1	37	245.0	87.0	89.0	89.0	60.0	72.0	78.5	
30	22	380	50	965	214	265	295	26.4	34.5	45	280.0	90.0	90.5	90.0	70.5	80.0	84.5	0.190
		415		965	213	325	370	29.	36.2	44	310.0	87.5	89.5	89.5	58.5	71.0	77.5	
40	30	380	50	965	291	225	280	36.2	47.1	61	380.0	90.5	91.5	91.0	69.5	79.5	84.0	0.333
		415		970	291	275	345	41.3	49.7	61	420.0	88.5	90.5	90.5	57.0	69.5	76.5	
50	37	380	50	970	360	230	275	43.8	57.5	74	455.0	91.5	92.0	91.5	70.0	80.0	84.0	0.382
		415		970	359	285	340	49.0	59.7	74	505.0	90.0	91.0	91.0	58.5	71.0	77.5	
60	45	380	50	970	438	250	275	50.8	67.8	88	535.0	92.0	92.0	91.0	73.5	82.5	86.0	0.430
		415		975	437	300	330	57.8	71.1	88	590.0	90.0	91.0	91.0	60.0	72.5	79.0	
75	55	380	50	975	533	255	265	58.7	80.1	105	695.0	93.0	93.0	92.5	76.5	84.0	86.5	0.880
		415		975	532	310	325	62.4	79.9	105	770.0	92.0	93.0	92.5	66.5	77.0	82.0	

2 pole

60Hz

Rated		Poles	Volt	Hz	Rated	Torque			Current				Efficiency			Power Factor		
Output					Speed	Rated	Start	Max	50%	75%	100%	Start	50%	75%	100%	50%	75%	100%
HP	kW				(min-1)	(Nm)	(%)	(%)	(A)	(A)	(A)	(A)	(%)	(%)	(%)	(%)	(%)	(%)
1/2	0.4	2	220	60	3480	1.10	245	320	1.1	1.3	1.6	10.0	71.5	75.0	75.0	69.5	81.5	88.0
			380		3480	1.10	245	320	0.61	0.75	0.90	5.8	71.5	75.0	75.0	69.5	81.5	88.0
			440		3500	1.09	330	380	0.67	0.76	0.88	6.8	67.0	73.0	75.0	58.0	71.0	79.5
1	0.75	2	220	60	3470	2.07	190	245	1.7	2.3	2.8	16.5	77.0	79.0	78.0	77.0	86.0	90.0
			380		3470	2.07	190	245	0.96	1.3	1.6	9.5	77.0	79.0	78.0	77.0	86.0	90.0
			440		3490	2.05	265	340	1.0	1.2	1.5	11.5	74.5	78.5	79.0	65.0	77.0	84.0
2	1.5	2	220	60	3470	4.13	200	240	2.9	4.0	5.4	31	80.0	81.5	80.0	83.0	90.0	93.0
			380		3470	4.13	200	240	1.7	2.3	3.1	18.0	80.0	81.5	80.0	83.0	90.0	93.0
			440		3490	4.11	275	325	1.8	2.2	2.7	21	79.0	81.5	82.0	71.5	82.0	87.5
3	2.2	2	220	60	3430	6.13	260	240	4.2	5.7	7.6	54	84.0	84.5	83.0	82.5	90.0	92.5
			380		3430	6.13	260	240	2.4	3.3	4.4	31	84.0	84.5	83.0	82.5	90.0	92.5
			440		3460	6.08	365	340	2.5	3.2	3.9	37	83.0	85.0	84.5	69.5	81.0	86.5
5	3.7	2	220	60	3420	10.3	220	260	6.4	9.2	12.3	83	83.5	84.5	83.5	90.5	93.5	94.0
			380		3420	10.3	220	260	3.7	5.3	7.1	48	83.5	84.5	83.5	90.5	93.5	94.0
			440		3460	10.2	315	355	3.6	4.8	6.2	57	83.0	85.5	85.5	82.5	89.0	91.5
7.5	5.5	2	380	60	3480	15.1	185	240	5.6	7.9	10.5	65	85.0	87.0	87.0	87.5	90.5	91.0
			440		3510	15.0	265	340	5.3	7.1	9.2	77	85.0	87.5	88.5	80.0	86.5	89.5
10	7.5	2	380	60	3480	20.6	200	235	7.4	10.6	14.0	90	86.5	88.5	88.5	88.5	91.5	91.5
			440		3510	20.4	290	335	6.9	9.4	12.1	107	86.5	88.5	89.5	82.5	88.5	90.5
15	11	2	380	60	3490	30.1	225	245	10.7	15.2	20.0	128	87.5	89.0	89.0	90.0	92.5	92.5
			440		3520	29.9	320	350	10.4	14.0	17.9	152	86.0	89.0	89.5	80.5	87.5	90.0
20	15	2	380	60	3490	41.1	260	275	14.2	20.4	27.3	178	89.0	90.5	90.0	90.0	92.5	93.0
			440		3520	40.7	370	390	13.8	18.7	24.1	212	88.0	90.0	90.5	81.0	87.5	90.0
25	18.5	2	380	60	3490	50.6	255	255	17.2	24.8	33.1	224	90.0	91.0	91.0	91.0	93.5	93.5
			440		3520	50.2	365	365	16.6	22.7	29.2	266	89.0	91.0	91.5	82.0	88.5	91.0

4 pole

60Hz

Rated		Poles	Volt	Hz	Rated	Torque			Current				Efficiency			Power Factor			Moment of Inertia J (kg . m ²)
Output					Speed	Rated	Start	Max	50%	75%	100%	Start	50%	75%	100%	50%	75%	100%	
HP	kW				(min ⁻¹)	(Nm)	(%)	(%)	(A)	(A)	(A)	(A)	(%)	(%)	(%)	(%)	(%)	(%)	
1/2	0.4	4	220	60	1690	2.26	225	255	1.1	1.4	1.7	7.3	75.0	76.5	75.0	62.5	75.5	83.5	0.000973
			380		1690	2.26	225	255	0.65	0.79	0.98	4.2	75.0	76.5	75.0	62.5	75.5	83.5	
			440		1710	2.24	310	355	0.74	0.83	0.98	4.9	70.5	75.0	76.0	50.0	63.5	73.0	
1	0.75	4	220	60	1700	4.22	195	260	1.7	2.3	2.9	13.7	81.0	81.0	78.0	70.5	81.0	85.5	0.002130
			380		1700	4.22	195	260	1.0	1.3	1.7	7.9	81.0	81.0	78.0	70.5	81.0	85.5	
			440		1710	4.19	280	370	1.0	1.3	1.5	9.5	79.0	81.5	81.0	59.5	72.5	79.5	
2	1.5	4	220	60	1710	8.38	190	210	3.5	4.5	5.9	29	82.5	82.0	79.5	70.5	81.0	85.5	0.00330
			380		1710	8.38	190	210	2.0	2.6	3.4	16.5	82.5	82.0	79.5	70.5	81.0	85.5	
			440		1730	8.28	265	300	2.1	2.5	3.0	20.0	80.5	82.5	82.0	58.0	71.5	79.0	
3	2.2	4	220	60	1710	12.3	190	225	4.7	6.2	8.1	43	84.0	83.5	81.0	75.0	84.0	87.5	0.00570
			380		1710	12.3	190	225	2.7	3.6	4.7	25	84.0	83.5	81.0	75.0	84.0	87.5	
			440		1730	12.2	270	320	2.8	3.5	4.3	29	82.0	84.0	83.5	62.5	75.0	81.5	
5	3.7	4	220	60	1700	20.8	185	215	7.1	10.0	13.5	71	86.5	85.5	82.0	78.5	86.0	88.0	0.01100
			380		1700	20.8	185	215	4.1	5.8	7.8	41	86.5	85.5	82.0	78.5	86.0	88.0	
			440		1730	20.4	265	310	4.3	5.4	6.8	49	85.0	86.0	85.0	66.5	78.0	83.5	
7.5	5.5	4	380	60	1720	30.6	200	245	5.9	8.1	10.7	60	89.0	89.0	87.5	79.0	86.5	89.0	0.01710
			440		1740	30.2	270	330	6.1	7.7	9.6	70	88.0	89.0	89.0	68.0	79.0	84.5	
10	7.5	4	380	60	1720	41.7	230	260	7.9	10.9	14.4	86	89.5	89.5	88.5	80.5	87.5	89.5	0.01110
			440		1740	41.2	325	360	7.9	10.2	12.8	101	88.5	89.5	89.5	70.0	81.0	86.0	
15	11	4	380	60	1730	60.8	200	220	11.1	15.7	20.9	116	90.0	90.0	89.0	83.5	88.5	90.0	0.03450
			440		1750	60.1	265	300	11.2	14.7	18.7	135	89.0	90.0	90.0	72.0	81.5	86.0	
20	15	4	380	60	1740	82.4	220	250	14.9	21.1	28.1	167	91.5	91.0	90.0	84.0	89.0	90.5	0.04460
			440		1750	81.9	295	335	14.9	19.6	24.9	193	90.5	91.5	91.0	73.0	82.5	86.5	

6 pole

60Hz

Rated		Poles	Volt	Hz	Rated	Torque			Current				Efficiency			Power Factor			Moment of Inertia J (kg . m ²)
Output					Speed	Rated	Start	Max	50%	75%	100%	Start	50%	75%	100%	50%	75%	100%	
HP	kW				(min ⁻¹)	(Nm)	(%)	(%)	(A)	(A)	(A)	(A)	(%)	(%)	(%)	(%)	(%)	(%)	
1/2	0.4	6	220	60	1130	3.38	195	250	1.4	1.6	1.9	7.8	71.5	74.0	72.5	54.0	67.5	76.5	0.002150
			380		1130	3.38	195	250	0.78	0.91	1.1	4.5	71.5	74.0	72.5	54.0	67.5	76.5	
			440		1140	3.35	275	355	0.87	0.95	1.1	5.4	67.5	72.5	74.0	44.5	57.0	66.5	
1	0.75	6	220	60	1120	6.40	180	215	2.4	2.9	3.6	13.7	73.0	74.0	71.5	56.5	69.5	77.5	0.004600
			380		1120	6.40	180	215	1.4	1.7	2.1	7.9	73.0	74.0	71.5	56.5	69.5	77.5	
			440		1140	6.29	240	290	1.6	1.7	2.0	9.1	70.0	73.5	74.0	45.5	58.5	68.0	
2	1.5	6	220	60	1110	12.9	180	210	3.8	4.8	6.4	28	80.0	79.5	75.5	64.5	76.0	81.5	0.00870
			380		1110	12.9	180	210	2.2	2.8	3.7	16.0	80.0	79.5	75.5	64.5	76.0	81.5	
			440		1130	12.7	240	280	2.4	2.8	3.4	19.0	77.5	79.5	79.0	52.5	66.0	74.0	
3	2.2	6	220	60	1120	18.8	220	280	5.2	6.8	8.5	47	83.0	83.5	81.0	66.5	78.0	83.5	0.01320
			380		1120	18.8	220	260	3.0	3.9	4.9	27	83.0	83.5	81.0	66.5	78.0	83.5	
			440		1140	18.4	315	375	3.3	3.8	4.6	32	81.0	83.0	83.0	54.5	68.0	76.5	
5	3.7	6	380	60	1100	32.1	170	210	4.5	6.1	8.1	40	86.0	84.5	81.5	72.5	81.5	85.0	0.02560
			440		1130	31.3	240	300	4.6	5.8	7.2	48	85.0	86.0	84.5	61.5	74.0	80.5	
7.5	5.5	6	380	60	1130	46.5	185	220	6.6	8.9	11.8	61	89.0	89.0	87.0	71.5	79.5	81.5	0.03430
			440		1150	45.7	265	320	6.8	8.5	10.5	72	88.0	89.0	88.5	60.0	71.5	77.5	
10	7.5	6	380	60	1150	62.3	205	305	8.6	11.5	14.8	98	89.0	89.5	88.0	74.0	83.5	87.5	0.05510
			440		1160	61.8	295	440	9.2	11.2	13.7	117	87.5	89.0	89.0	61.0	74.0	81.0	
15	11	6	380	60	1150	91.4	185	280	11.9	16.2	21.2	138	90.5	90.5	89.0	77.5	85.5	88.5	0.07270
			440		1160	90.6	270	405	12.3	15.4	19.2	164	89.0	90.0	90.0	66.0	78.0	83.5	

DRIP PROOF TYPE SPLIT-PHASE START SINGLE-PHASE MOTORS CAPACITOR START, CAPACITOR START CAPACITOR RUN 1/8 HP → 10 PH

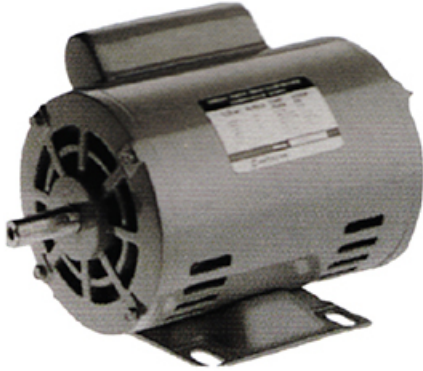

Model:

xxHP or kW + Type-From + xP

Output

No of pole

SPECIFICATIONS

ITEM	SPECIFICATION		
STANDARD	JIS C4203, 4034		
RATING	CONTINUOUS [S1]		
INSULATION CLASS	E TYPE		
ENCLOSURES TYPE PROTECTION	ENCLOSURES		PROTECTION
	TYPE	TYPE	PROTECTION
	OPEN	DRIP	EFOU-KT, KA, KQ
		PROOF	EFOUP-KT, KR, KQ
			JP22
VOLTAGE, FREQUENCY	220V 50Hz		
TYPE OF CABLE	Made from high temperature resistance plastic (end of pole conduct electric current)		
NUMBER OF CABLE	4 WIRES (1/4-1/3 HP-KT.-KR 2-10 HP-KQ) 3 WIRES (1/2-1.5 HP-KR-KQ)		
COLOUR	Rigail grey (MUNSELL 8.9Y5.1/0.3)		
TRANSMISSION	DIRECT COUPLING OR BELT DRIVE		
ROTATION	CW (VIEW FROM MOTOR DRIVE END)		
ENVIRONMENT	TEMPERATURE	-21°C – 40°C	
	HUMIDITY	MAX 90% RH	
	ALTITUDE	MAX 1,000 m	
	ESTABLISHMENT	IN DOOR	
ATMOSPHERE	NO CORROSIVE GAS, NO EXPLOSIVE GAS, NO STEAM, NO DEW, LITTLE DUST		

DIMENSIONS (in mm)

Type-From	Out Put (HP)	Fig. No	Ins. Class	Dimension in mm																	Bearing No.							
				L	R	A	B	D	KL	J	H	C	F	E	N	M	G	Z	XB	S	W	U	T	Q	QK	QR	Drive end Side	Opposite Side
EFOU-KT	1/8	1	E	30	25	58	110	150	3.2	150	3.2	58	25	58	110	150	3.2	58	45	150	-	1	-	30	27	-	6202 ZZ	6202 ZZ
EFOU-KT	1/4	1	E	35	45	58	110	150	3.2	150	3.2	58	45	58	110	150	3.2	58	45	150	-	1	-	30	27	-	6202 ZZ	6202 ZZ
EFOU-KT	1/3	1	E	35.5	45	58	110	150	3.2	150	3.2	58	45	58	110	150	3.2	58	45	150	-	1	-	30	27	-	6202 ZZ	6202 ZZ
EFOUP-KT	1/2	2	E	45	60	45.5	125	150	3.2	150	3.2	45.5	60	45.5	125	150	3.2	45.5	50	150	5	3	5	40	-	0.3	6202 ZZ	6202 ZZ
EFOU-KR	1/8	3	E	45	45	55	110	150	3.2	150	3.2	55	45	55	110	150	3.2	55	45	150	-	1	-	30	27	-	6202 ZZ	6202 ZZ
EFOU-KR	1/4	3	E	50	45	55	110	150	3.2	150	3.2	55	45	55	110	150	3.2	55	45	150	-	1	-	30	27	-	6202 ZZ	6202 ZZ
EFOU-KR	2/5	3	E	50	45	55	110	150	3.2	150	3.2	55	45	55	110	150	3.2	55	45	150	-	1	-	30	27	-	6202 ZZ	6202 ZZ
EFOU-KR	1/3	3	E	60	45	55	110	150	3.2	150	3.2	55	45	55	110	150	3.2	55	45	150	-	1	-	30	27	-	6202 ZZ	6202 ZZ
EFOUP-KR	1/2	4	E	60	50	62.5	125	160	3.2	160	3.2	62.5	50	62.5	125	160	3.2	62.5	50	160	5	3	5	40	-	0.3	6203 ZZ	6202 ZZ
EFOUP-KR	1	4	E	90	62.5	70	155	175	4	175	4	70	62.5	70	155	175	4	70	50	175	5	3.5	5	40	-	0.3	6204 ZZ	6202 ZZ
EFOUP-KQ	1.5	5	E	90	62.5	70	155	175	4	175	4	70	62.5	70	155	175	4	70	60	175	6	3.5	6	40	-	0.3	6204 ZZ	6202 ZZ
EFOUP-KQ	2	5	B	110	70	80	175	205	4	205	4	80	70	80	175	205	4	80	60	205	8	4	7	60	-	0.5	6206 ZZ	6206 ZZ
EFOUP-KQ	3	6	B	110	70	85	175	224	7.5	224	7.5	85	70	85	175	224	7.5	85	70	224	8	4	7	60	-	0.5	6206 ZZ	6206 ZZ
EFOUP-KQ	5	7	B	100	80	106	212	256	16	256	16	106	80	106	212	256	16	106	80	256	10	6	8	60	-	0.5	6208 ZZ	6208 ZZ
EFOUP-KQ	7.5	7	B	100	88	106	212	256	16	256	16	106	88	106	212	256	16	106	80	256	10	6	8	60	-	0.5	6208 ZZ	6208 ZZ
EFOUP-KQ	10	7	B	100	88	106	212	256	16	256	16	106	88	106	212	256	16	106	80	256	10	6	8	60	-	0.5	6208 ZZ	6208 ZZ

Fig.1



Fig.2



Fig.3



Fig.4



Fig.5



Fig.6



Fig.7



Shaft Dimension

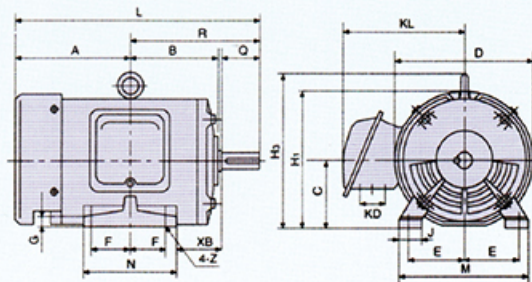
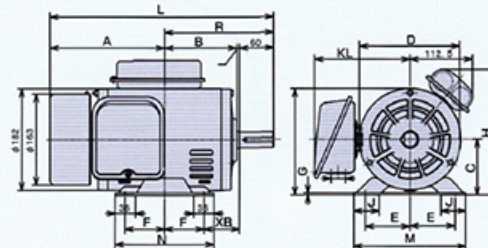
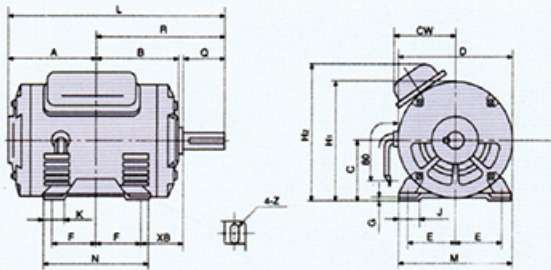
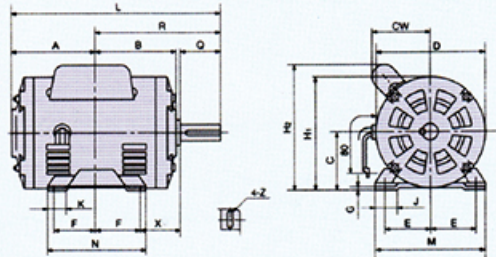
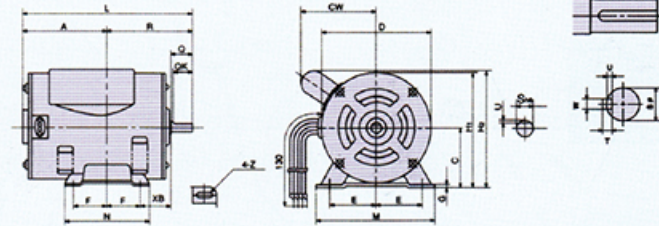

Type-From	Rated Output		INS. Class	Voltage (V)	Frequency (Hz)	Current (A)	Speed (min ⁻¹)
	HP	kW					
EFOU-KT	1/8	0.1	E	220	50	1.4	1450
EFOU-KT	1/4	0.2	E	220	50	2.3	1450
EFOU-KT	1/3	0.25	E	220	50	2.7	1430
EFOUP-KT	1/2	0.4	E	220	50	3.7	1400
EFOU-KR	1/8	0.1	E	220	50	2.2	1450
EFOU-KR	1/4	0.2	E	220	50	2.2	1450
EFOU-KR	2/5	0.3	E	220	50	2.8	1440
EFOU-KR	1/3	0.25	E	220	50	2.6	1440
EFOU-KR	1/2	0.4	E	220	50	3.4	1430
EFOU-KR	1	0.75	E	220	50	6.6	1410
EFOUP-KQ	1.5	1.1	B	220	50	10.0	1430
EFOUP-KQ	2	1.5	B	220	50	10.0	1430
EFOUP-KQ	3	2.2	B	220	50	13.0	1440
EFOUP-KQ	5	3.7	B	220	50	26.0	1450
EFOUP-KQ	7.5	5.5	B	220	50	33.0	1450
EFOUP-KQ	10	7.5	B	220	50	42.0	1440

Unique construction models



Resilient Base Mounting Model



Enclosure Type [TFEC Type]

Construction as total enclosure with fan cooled.

- Model : 0.4, 0.55, 0.7kW TFO-KQ 4P



- Model : 0.4kW TFO-KQ 4P

How to order the motors.

Model indication (Example):

xxHP (or kW) TFO-K(KK) xP IP55 + Voltage/Hz + Optional Spec.

Output Type No of pole

Please specify the model indication upon your inquiry when request.

Example : 3HP (or 2.2kW), 4 pole, Foot Mount, Protection class IP55, Voltage 380V 50Hz

For new installation

3HP (or 2.2kW) TFO-K 4P IP55 380V 50Hz

For replacement

3HP (or 2.2kW) TFO-K 4P IP55 380V 50Hz + MFG No.
MFG No. (Manufacturing No.) is also need to check specifications

Model Explanation

Three-Phase

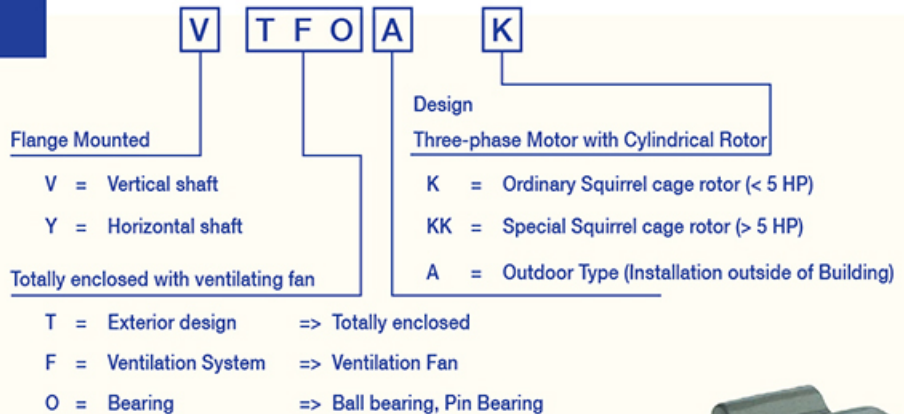

Single-Phase

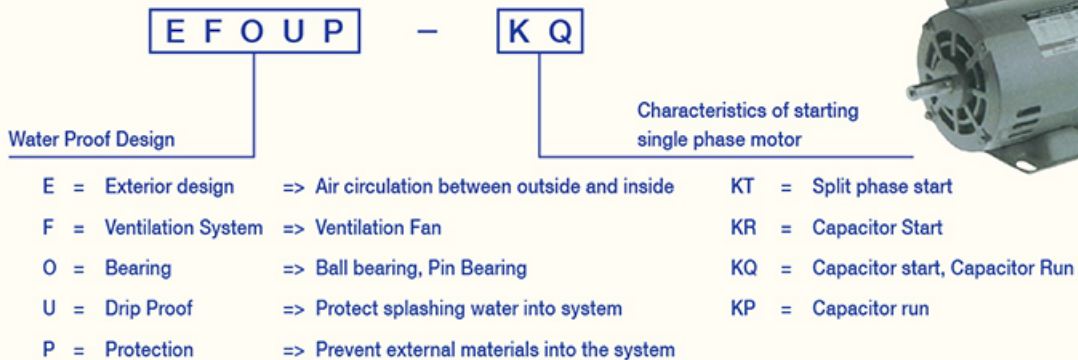

kW and HP comparable table

HP	1	2	3	5	7.5	10	15	20	25	30	40	50	60	75	100	120	150	175
kW	0.75	1.5	2.2	3.7	5.5	7.5	11	15	18.5	22	30	37	45	55	75	90	110	132

Other Line-up



Premium High-Efficiency Motors

Equivalent to IE3 class



High-Efficiency Motors

Equivalent to IE2 class



Brake Motors

On Brake & Off Brake model

Brake model : HBA, FA, NA

Output : 0.2~30kW (in case 4 pole)



Gear Motors

GA/GH-series (For General load)

Output : 0.2~11kW 1/5~1/100



High-Pressure Blowers

Vortex Blower

E-series (Large air flow type)

G-series (High-pressure type)

DN-series (General type)



Water Pumps

JD Type : Circulation Pumps

JL Type : In-line Pumps

Output : 0.25kW~11kW

Inverters (For variable speed operation)

Powerful model

WJ200 Series

Pursuing the Ideal Compact Inverter



SJ700 Series

High performance with Many useful Functions and, yet User Friendly



General Purpose model

NE-S1 series

อินเวอร์เตอร์รุ่นประหยัด

NEW



X200 Series

Simple, Trip-suppression and Eco-friendly Compact Inverter



SJ700B Series

Inverter designed for fans & pumps plus conveyors





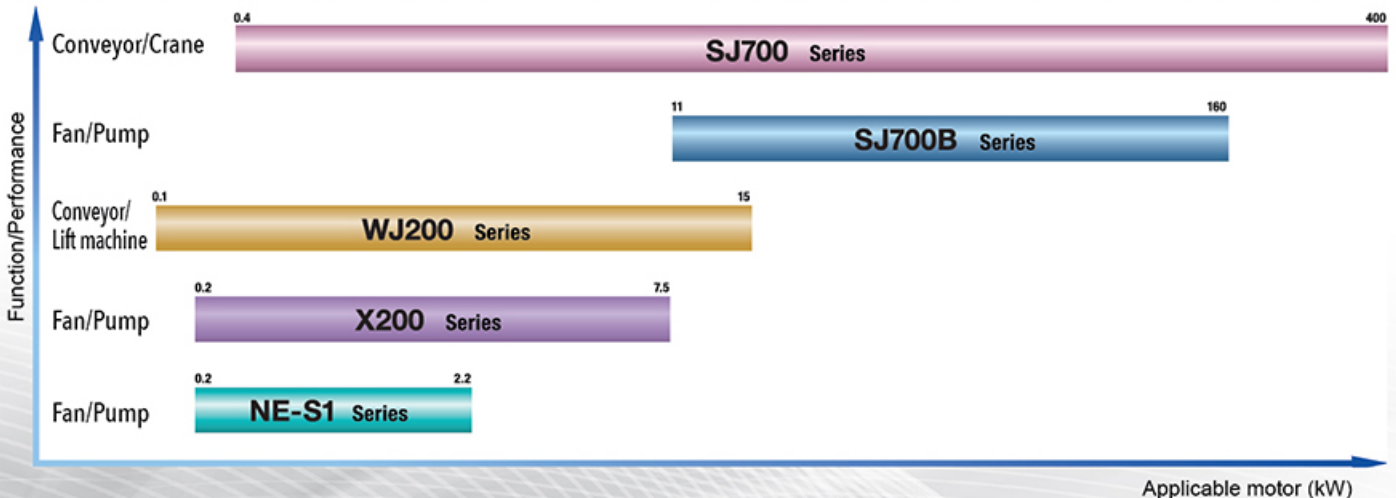



Model	kW (HP)	0.1 (1/8)	0.2 (1/4)	0.4 (1/2)	0.55 (3/4)	0.75 (1)	1.1 (1.5)	1.5 (2)	2.2 (3)	3 (4)	3.7 (5)	4 (5)	5.5 (7.5)	7.5 (10)	11 (15)	15 (20)	18.5 (25)	22 (30)	30 (40)	37 (50)	45 (60)	55 (75)	75 (100)	90 (125)	110 (150)	132 (175)	150 (200)	160 (220)	185 (250)	220 (300)	315 (400)	400 (500)		
NE-S1	1-phase 200V class																																	
	3-phase 200V class																																	
WJ200	1-phase 100V class																																	
	1-phase 200V class																																	
	3-phase 200V class																																	
	3-phase 400V class																																	
X200*	1-/3-phase 200V class				Note 3	Note 3																												
	3-phase 200V class																																	
	3-phase 400V class									Note 3	Note 4																							
SJ700	3-phase 200V class																																	
	3-phase 400V class										Note 5	Note 4															Note 2	Note 2						
SJ700B	3-phase 400V class																																	





Switches (Contactors & Breakers)

Electromagnetic Contactors

Electromagnetic Contactors		Electromagnetic Contactors				
		Without Enclosure		With Enclosure		
Non-reversible Type		HS [] [] 8 - 50 frame		HS [] [] -T 8 - 50 frame		SHS [] [] -T 10 - 50 frame
		H [] [] 65C - 800C frame		H [] [] -T 65C - 600C frame		SH [] [] -T 65C - 600C frame
Reversible Type [20 - 800C frame (provided mechanical interlock)]		HS [] [] -R 10 - 50 frame		HS [] [] -RT 10 - 50 frame		SHS [] [] -RT 10 - 50 frame
		H [] [] -R 65C - 800C frame		H [] [] -RT 65C - 600C frame		SH [] [] -RT 65C - 600C frame

Contactor Relays

XS4 	X [] []  3 - 8 contacts (5 types)
--	--

Thermal Overload Relays

 12 - 600A (9 types)	TR [] [] - [] [] (Electromagnetic Switches with Thermal Overload Relay) H [] [] -T H [] [] -TK with 25 Thermal Overload Relay
--	--

DC Operated Electromagnetic Relays

 10 - 800C frame	H [] [] -G
--	---------------------



Latched Electromagnetic Relays

 10 - 600C frame	H [] [] -L
--	---------------------

Heavy Load Electromagnetic Relays

 10 - 200N frame	H [] [] -H
--	---------------------

Fuse-Free Breaker

Standard Breaker	Economical Breaker	High Interrupting Capacity Breaker
 Fundamental F series 30A-4000A Frame	 Small S series 30A-800A Frame	 Current Limiting L series 50A-800A Frame

Air-Circuit Breaker

AKN, AKS, AKH Series
 630 - 6,300 AF

Memo



Technical Managements

Special Instruction

[Inspect the machine before use]

Please inspect the following area before turning on the switch ;

- Inspect if the following area are in ground wiring and insulation wiring,
- Inspect preventive apparatus and control circuit if they are working properly.
- Is the value of insulation resistance less than 1MΩ or not.
- Inspect if machine installation (direct belt) is correctly done.

[Precaution during use]

- Should be careful in loading capacity and frequency in turning on the machine.
Machine should not be on for a long period of time.
- If the motor rotates in a wrong direction, in case of three-phase motor, swap the two wires. In case of single-phase motor, re-wiring following the connection circuit.
- Voltage Amp should be within a correct limitation.
 - Is voltage amp correct as indicated in the instruction manual ?
 - Is there any balance in voltage amp for three-phase line ?
 - Is the electrical distributed power higher than the indicated limitation ? It should be adjusted to an appropriate loading capacity.
 - Inspect to make sure there is no vibration sound and abnormal heating.

Outdoor Installation

- Use a motor that has a totally enclosed with cooling fan and can be placed outside a building. The motor can be installed outside because it can prevent any water droplets in between core structures. The terminal box should have water protection and seal that can prevent water coming into lead wire connection. Insulated wires can tolerate humidity and seal that can prevent water seeping into lead wire connection.
- You can connect wires in steel tubed connection on the side (For wire connection of motor outside the building, you should follow the instructional pictures in preventing rain from iron pipe seeping into the terminal box).
- General type of totally enclosed motor with cooling fan is IP44 class. If installing in high dust area, you can use IP54 class. In case having water injection into a machine, you can use IP55 class.

Maintenance

[Daily basis]

- Surrounding environment :
Inspect the temperature around the entire machine, humidity, dust, gas and ventilation system.
- Working essentials :
Inspect the electric distribution (loading capacity), frequency and voltage amp.
- Loading condition and machine connection :
Inspect the tension of connecting belt.
- Condition around machine connection area :
Vibration and sound for making sure if it's working properly.

[Periodic basis]

- Should be inspected
Bearings, insulating stator (no less than 1MΩ, looseness of any bolt and nut, colors, etc. Including inspection of motor condition if it's working correctly at least once a year.

Installation Example

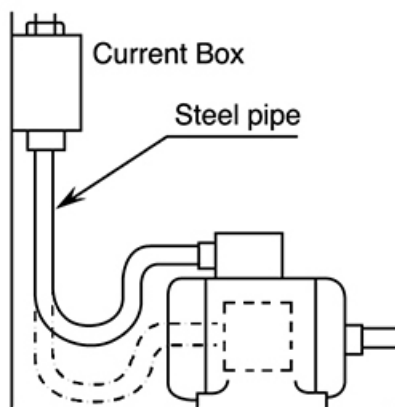

Hitachi Asia, Ltd.
Hitachi Industrial Technology (Thailand), Ltd.

For furthermore information, please contact to nearest sales representative.